

ALL-IN-ONE HEAT PUMP WATER HEATER USER MANUAL

MODEL NUMBERS:

Residential:

EE-HWS-A1-220 EE-HWS-A1-220E

EE-HWS-A1-270 EE-HWS-A1-270E

Commercial:

EE-HWS-A1-220-1 EE-HWS-A1-220E-1

EE-HWS-A1-270-1 EE-HWS-A1-270E-1

Thank you for choosing Emerald Energy.

This leaflet contains important information on the correct installation and operation of your heat pump water heater.

Read these instructions carefully before installation.
Keep this manual in a handy for future reference.



IMPORTANT NOTICE

Please read this manual carefully before you attempt to install this product. Failure to do so may result in the product not working according to its design.

CONTENTS

SAFETY PRECAUTIONS	2
GENERAL INFORMATION	3
PART NAMES	4
INSTALLATION	5
PLUMBING CONNECTION	7
ELECTRICAL CONNECTION	10
CONTROLLER INSTRUCTIONS	12
COMMISSIONING THE SYSTEM	17
OPERATION AND MAINTENANCE	19
AFTER SALES SERVICE	20

SAFETY PRECAUTIONS

INSTALLATION & OPERATION

- The installation must comply with the AS/NZS 5149 Standards.
- DO NOT install or operate this system before reading the manufacturer's instructions.
- This appliance must be installed, commissioned and serviced by an authorized person in accordance with all applicable local rules and regulations.
- Removing access covers and or water heating system components will expose 240V wiring and MUST only be removed by an authorised person.
- If the systems power supply is damaged, it MUST BE replaced by an authorised person in order to avoid a hazard. Take care not to touch the power connections or plugs with wet hands.
- This appliance is not intended for use by persons (including children) with reduced physical, sensory or mental capabilities, or lack of experience and knowledge, unless they have been given supervision or instruction concerning use of the appliance by a person responsible for their safety. Children should be supervised to ensure they DO NOT play with the appliance.
- For continued safety of this appliance it must be installed, operated and maintained in accordance with the manufacturer's instructions.
- Care should be taken not to touch the pipe work as it may be HOT!
- DO NOT place articles on or against this appliance.
- DO NOT store chemicals or flammable materials near this appliance.
- DO NOT operate with collectors or covers removed from this appliance.
- DO NOT activate heat pump unless cylinder is full of water.
- Household electrics must have a reliable earth connection.
- This product must be protected with a residual current device of adequate rating.
- Do not interfere with any permanent instruction, labels or warning plate attached to the external cover of this heat pump.
- This product must be installed by qualified person in the mechanical and electrical industry.
- Always comply with local wiring regulations.
- Always engage with a trained professional to relocate this product after it has been professionally installed.
- Maintenance and repair work must only be undertaken by trained and qualified personnel.
- The electrical connection to this product must be via a 20A RCD/ MCB or RCBO with a test button function.
- This appliance should never be used by children.
- Do not operate this heat pump in a wet room such as a bathroom or unless it is housed in a separate cupboard within that room.

INSTALLATION & OPERATION

- This appliance uses R290 (propane) refrigerant, which is a flammable gas class 3 according to AS 1677 and must be handled by a refrigeration mechanic with appropriate Australian refrigerant handling license.
- WARNING Risk of fire/flammable material. If the refrigerant is leaked, together with an external ignition source, there is a possibility of ignition.
- DO NOT store chemicals or flammable materials near this appliance.
- NEVER use a flammable spray such as hair spray, paint, etc near this unit as this may cause a fire.
- The appliance should not be stored or transported in an area with an ignition source (e.g. open flame).
- Do not pierce or burn the appliance.
- Be aware that the refrigerant may not cause an odour.
- Compliance with AS/NZS 5601 must be observed while storing the appliance.
- National and state regulations exist for the storage, transportation and handling of hazardous goods including flammable gasses. The maximum number of and configuration of the equipment permitted to be transported or stored together will be determined by the appliance regulations.

WARNING

- Risk of fire/flammable material. If the refrigerant is leaking, switch off the unit at the mains and contact the service agent.
- DO NOT store chemicals or flammable materials near this appliance.
- NEVER use a flammable spray such as hair spray, paint, etc near this unit as it may cause fire.
- Avoid risk of injury from contact with refrigerant if you notice a leak.
- If you suspect the refrigerant is leaking then Do not smoke or operate electrical equipment.
- End of life recycling: The refrigerant must not enter the atmosphere. Only have the refrigerant removed by qualified professional.

If the hot water system is not used for two weeks or more, a quantity of highly flammable hydrogen gas may accumulate in the water heater. To dissipate this gas safely, it is recommended that a hot tap be turned on for several minutes or until discharge of gas ceases. Use a sink, basin, or bath outlet, but not a dishwasher, clothes washer, or other appliance. During this procedure, there must be no smoking, open flame, or any electrical appliance operating nearby. If hydrogen is discharged through the tap, it will probably make an unusual sound as with air escaping.

GENERAL INFORMATION

MEASUREMENT

MODEL	WEIGHT (kg)	DIMENSION (mm)	POWER SUPPLY
EE-HWS-A1-220(-1)	118	600×1598	220V-240V/ 50Hz
EE-HWS-A1-220E(-1)	118	600×1598	220V-240V/ 50Hz
EE-HWS-A1-270(-1)	136	600×1826	220V-240V/ 50Hz
EE-HWS-A1-270E(-1)	136	600×1826	220V-240V/ 50Hz

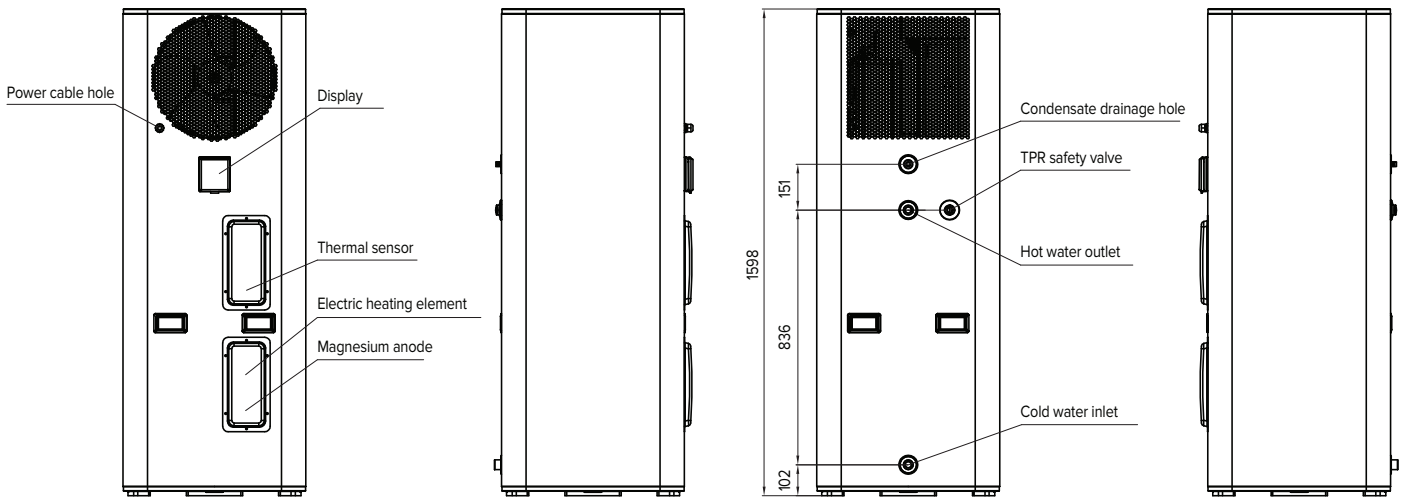

EE-HWS-A1-220E(-1)

(The electric heating element is not included in EE-HWS-A1-220)

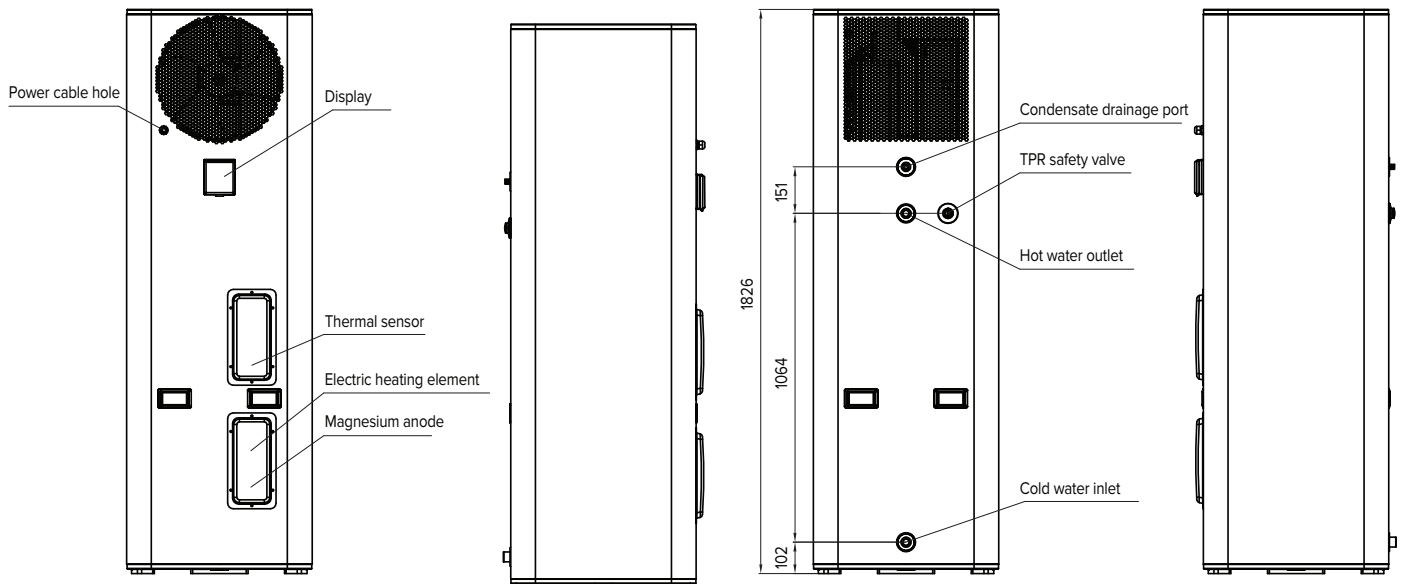

EE-HWS-A1-270E(-1)

(The electric heating element is not included in EE-HWS-A1-270)

GENERAL INFORMATION

EXPLODED DRAWING

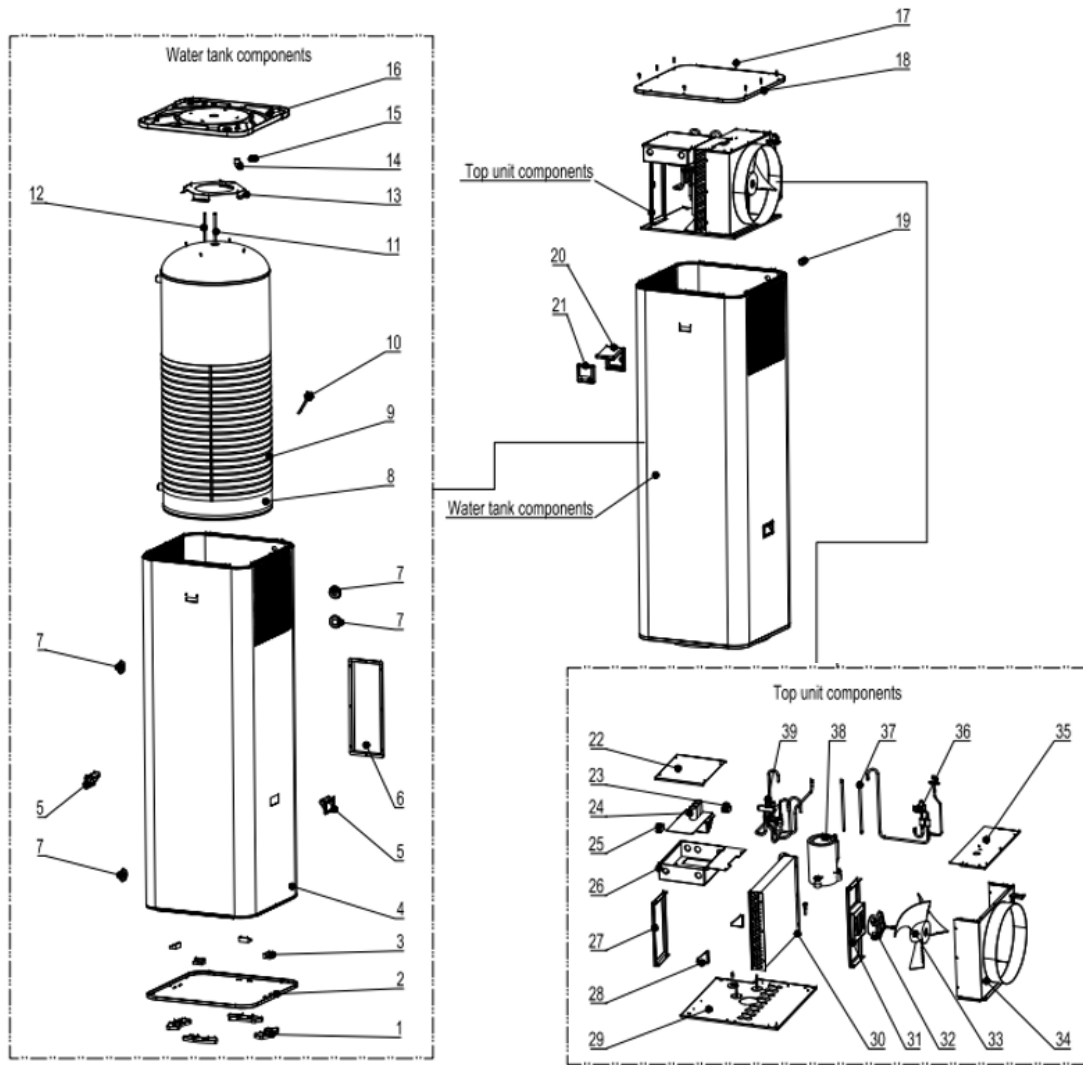

No.	DESCRIPTION	QTY	REMARK
1	Feet	4	PP
2	Bottom tray	1	Galvanized plate
3	Position block	4	PP
4	Outer casing	1	Galvanized plate
5	Hand grip	2	ABS
6	Electric heater cover	1	Galvanized plate
7	Decorative rubber ring	4	ABS
8	Enamel tank	1	
9	Microchannel heat exchanger	1	Aluminium alloy
10	Electric heater	1	
11	Microchannel outlet	1	TP2M
12	Microchannel inlet	1	TP2M
13	Bottom bracket	1	Galvanized plate
14	Curve adapter	1	PVC
15	Condensate drainage port	1	PVC
16	Condensate tray	1	ABS
17	Self tapping screw	8	
18	Top lid	1	Galvanized plate
19	Power cable screw	1	PP

20	Controller cover	1	PVC
21	Controller	1	
22	Electric box cover	1	Galvanized plate
23	Terminal block	1	
24	Main board	1	
25	Relay	1	
26	Electric box	1	Galvanized plate
27	Electric box bracket	1	Galvanized plate
28	Evaporator bracket	2	Galvanized plate
29	Top unit tray	1	Galvanized plate
30	Evaporator	1	
31	Fan motor bracket	1	Galvanized plate
32	Fan motor	1	
33	Fan blade	1	ASG20
34	Fan box	1	
35	Fan box cover	1	
36	EEV	1	
37	Transition pipe	1	TP2M
38	Compressor	1	
39	4 way valve	1	

*The electric heating element is not included in EE-HWS-A1-220(-1) & EE-HWS-A1-270(-1)

INSTALLATION

All Emerald Energy heat pumps are designed for installation by a licensed plumber in accordance with standards set out in AS/NZS 3500.2 "National Plumbing and Drainage Code Hot Water Supply Systems - Acceptable Solutions".

CHOOSE A SUITABLE LOCATION

1. Ideally the Heat Pump should be installed outdoors only. For indoor installations the ensure that the location complies with the requirements of AS/NZS 5149.
2. Please ensure there is adequate space for installation and maintenance. It is recommended a head height of 300mm is required.
3. The product is to be installed in a dry and free from humidity location.
4. Support surface must be flat (horizontal angle must not be more than 2°), and can hold the products weight when filled with water. Please refer to the technical data sheet for the products weight.
5. Please select a suitable location for the exhaust air vent to the outside. Always insulate the exhaust air ducting to avoid condensation when operational.
6. Please ensure there is access to the removal front panel for maintenance.
7. Always allow extra room for pipe connections and power cables.
8. Always refrain from installing on a surface with loose coverings as the product may make a vibrating noise when operating.
9. The areas containing toxic gases or mineral oils are not recommended as suitable installation locations of the product.

 The Emerald integrated series uses a flammable gas, therefore:

- The appliance should not be stored or transported in an area with an ignition source
- Do not pierce or burn the appliance.
- Be aware that the refrigerant may not cause an odour.
- Compliance with AS/NZS 5601 must be observed while storing the appliance.

National and state regulations exist for the storage, transportation and handling of hazardous goods including flammable gasses.

The maximum number of and configuration of the equipment permitted to be transported or stored together will be determined by the appliance regulations.

 If the product is installed in a location where there is a possibility of frost, then all precautions must be taken to ensure all pipework is sufficiently insulated.

TRANSPORTING THE HEAT PUMP

1. Emerald Energy heat pumps must be stored and transported in a near vertical position at all times with a tilt ratio of no more than 30°. Transporting or storing the unit in a horizontal position will void warranty.
2. The system should always be transported in it's packaging.
3. The weight of the package system is 138KG (EE-HWS-A1-220 & EE-HWS-A1-220E) and 156KG (EE-HWS-A1-270 & EE-HWS-A1-270E). The system must be handled by two people at all times to avoid unnecessary strain and damaged.
4. Please note the outer casing of the unit is susceptible to denting and damage. Care and consideration should be taken into account when moving the unit as any marks caused by inappropriate handling are not deemed as defects and are not covered under warranty.

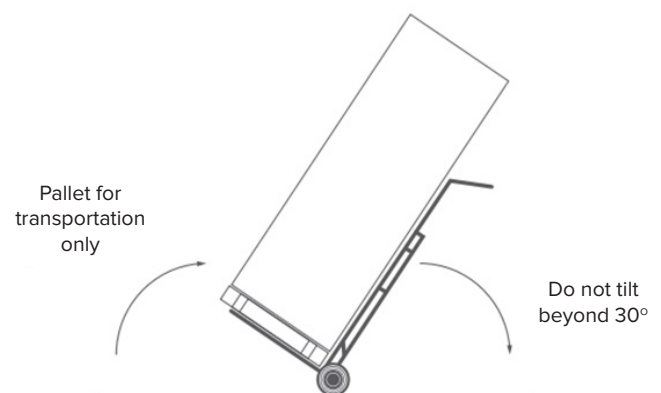

INSTALLATION

INSTALLATION OF THE HEAT PUMP

1. BASE

- The unit should be installed on a concrete plinth or stable structure capable of sustaining weights in excess of 400kg. The supporting structure must not shift over time (due to water drainage etc.). A concrete base of at least 50mm thick or a well-seasoned hardwood slat at least 25mm is required. If a concrete base paver is being used, a minimum dimension of 600mm x 600mm is required.
- Please ensure that all four feet are supported by the base being used otherwise warranties may be voided.
- Proper drainage should be observed for any overflow.
- When installed the unit must be completely vertical and level as to ensure that condensate can be properly drained. If the system is installed at a level with a tilt of more than 3 degrees, warranties may be voided.
- If property damage can occur due to water leakage, a safe tray (overflow tray) must be installed.

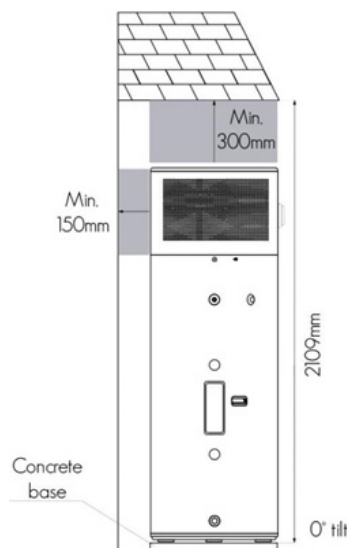

2. AIR FLOW

- This unit is designed for external operation only and requires a continuous supply of air to operate efficiently.
- Avoid installation in areas where falling debris such as leaves is prevalent as this may result in air vents being blocked or the unit being damaged.
- Avoid placing the system in locations with multiple walls or structures (Diagram 1 & 2).
- Always maintain optimum perimeter from all structures
- If installed under fixtures or home eaves, there must be a minimum 300mm clearance between the top of the unit, 600mm on the right hand side of the system (when facing unit) and 150mm on the left hand side of the system (when facing system) (see section 2.3 AIR FLOW). The unit must be installed a minimum of 150mm off your home's wall so that the entire unit can be accessed during any servicing work as well as to prevent circulation of cold air (see section 2.3 AIR FLOW). If the system cannot be properly serviced due to the system being installed outside of these specifications, the owner will be liable for the associated plumbing costs of draining and moving the system.
- The unit should be installed so that the control interface is accessible to users and that there is clear access to the electrical panel at the back of the system. Where incorrect installation has occurred warranties may be void or additional charges may be required to ensure that the system is compliant.

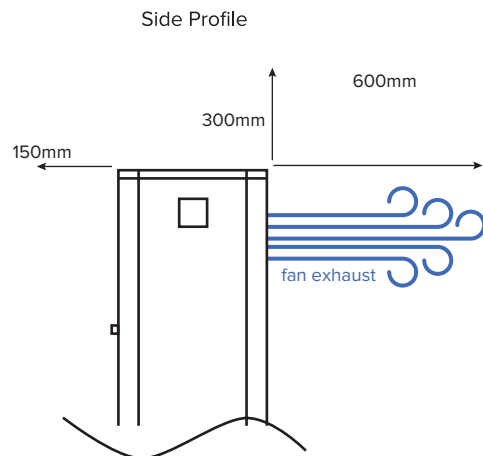

⚠ WARNING

- A minimum of 20m³ of unobstructed space surrounding the unit.
- For indoor installations the ensure that the location complies with the requirements of AS/NZS 5149.
- The electrical access point and display panel should always be accessible.

PLUMBING CONNECTIONS

PLUMBING CONNECTIONS

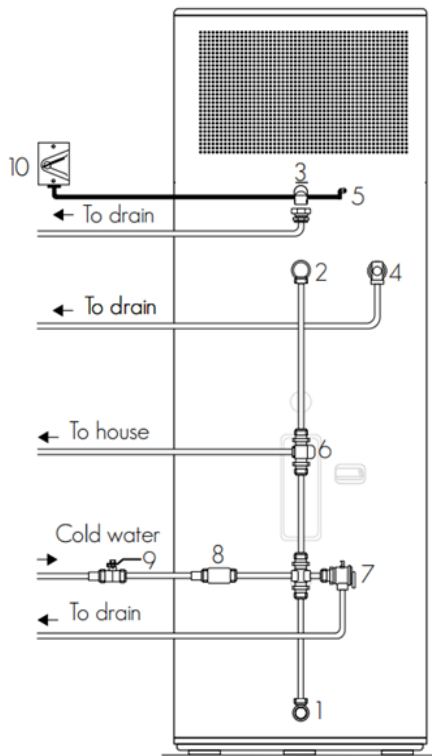

1	Cold water supply outlet (G 3/4" female thread)
2	Hot water outlet (G 3/4" female thread)
3	Condensing drainage Elbow*
4	P&T Relief Valve* (G 1/2" female) (850k Pa)
5	Electrical cable
6	Tempering valve (high performance recommended)
7	Expansion control valve (ECV)
8	Pressure reduction valve (500k Pa)
9	Non-return/Isolation valve
10	Isolation switch (hardwired into 10 amp circuit)
* Supplied with system	

COLD WATER SUPPLY OUTLET

- The cold water supply connection is a G 3/4" female thread.
- The cold water supply should be connected to G 3/4" socket.
- The cold water supply outlet can also act as a drainage point for emptying the system.

HOT WATER CONNECTION

- The hot water supply connection is a G 3/4" female thread.
- The hot water supply should be connected to G 3/4" socket.
- To ensure thermal efficiency all hot water lines and connections must be insulated with a minimum 13mm closed cell insulation.
- All hot water supply parts must be constructed from copper.

CONDENSATE DRAIN

- The process of heat extraction from the atmosphere through evaporator coils results in the production of water in the form of condensation. More humid environments will produce higher rates of condensation.
- To collect this water by-product a Condensate Tray is located at the bottom of the heat pump. Overflow from this tray runs out through the Condensate Drain.
- The system comes with a pre-installed condensate drain connection elbow. Drainage of condensate from elbow to

nearest storm water to be done by the collection of condensate into the drainage pipe. If not drained properly, the condensate line will attract termites as well produce algae and moss growth.

- The Condensate line should be free of kinks and as the water is gravity fed, should only be running down to ensure the free flow of water.

PRESSURE & TEMPERATURE RELIEF (TPR) VALVE

- The system is supplied with a loose TPR valve appropriate to the pressure rating of the water heater tank. If the TPR valve is not present please contact your supplier. The valve Rated capacity: 850kPa;10kW; Set temperature: 93-99°C.
- The supplied TPR valve must be installed at Point 4 in section 3.2 DYNAMIC X8 Connection Dimensions and Components under the socket marked "RELIEF VALVE".
- The TPR valve must be insulated with a minimum 13mm closed coupled insulation, to minimize heat lost.
- The relief valve must be installed so that the drain line is facing downwards at all times with the discharge point remaining open to the atmosphere.
- A discharge pipe connected to the pressure relief device is to be installed in a continuously downward direction and in a frost-free environment. Do not connect any pressure-relief device to the condensate drain pipe. The water may drip from the discharge pipe of the pressure-relief device. This pipe must be left open to the atmosphere. The pressure-relief device is to be operated regularly to remove lime deposits and to verify that it is not blocked.

PLUMBING CONNECTIONS

OPERATING THE TPR VALVE (FREQUENCY: EVERY HALF YEAR - REPLACE IF REQUIRED)

It is recommended to operate the TPR valve periodically to ensure water flows freely. If water doesn't flow freely, the TPR valve will need to be replaced.

- Locate the TPR valve on the left hand side of the unit.
- Carefully release the valve using the lever & release some water from the tank.

NOTE: Water expelled may be extremely hot.

- If water flows freely the TPR appears to still be in a suitable working condition.
- If water does not flow freely it would appear the TPR valve is due for replacement.
- If the TPR valve needs replacing, please contact your plumber or our service team for further assistance.

TEMPERING VALVE

- The systems are automatically programmed to produce hot water in excess of 50°C. As such, in accordance with AS/NZS3500, it is mandatory that a Tempering Valve is installed.
- We recommend a high performance or solar rated tempering valve is used to ensure a more accurate hot water delivery temperature.
- Your old hot water system might not have had a tempering valve installed before and therefore you will notice a change in the temperature of the hot water. This is normal and required under new legislation. Should you have any concerns, please contact your installer.

EXPANSION CONTROL VALVE

- Please observe local requirements with regards to the installation of an ECV (optional in most councils).
- When installing an ECV, ensure that the connecting pipe diameter no greater than that of the safety valve.
- Ensure the drain is sized to allow for water runoff, even in incidents where the safety valve has been fully opened.
- The drain outlet must always remain open to the atmosphere and must not have a closing function.
- The ECV should be rated at no more than 700kPa.

PRESSURE REDUCING VALVE

- This water heater is supplied with a TPR valve rated at 850kPa and is designed for direct connection to mains water supply with a pressure not exceeding this rating.
- Should main pressure fluctuate above this rating, a pressure limiting device (AS1357) should be connected at Connection Dimensions and Components.

NON-RETURN/ISOLATING VALVE

- It is compulsory that a non-returning/isolation valve is installed directly into the cold-water supply line feeding the system. This will allow the hot water system to be isolated from the rest of the homes water supply, making servicing, draining, and replacing the unit easy. A hose-set must not be used to connect the system to water supply.
- The non-return/isolation valve can be combined with a TPR valve to form a duo valve.

ALLOWABLE MIN-MAX FILLING WATER PRESSURE

Allowable min-max filling water pressure: Min 200KPA - Max 750KPA

THE DEMANDED QUALITY OF WATER

- The bad quality water will produce more scale and sand, so this kind of water should be filtered.
- The water quality should be analyzed before system running, to measure the PH value, conductivity, Chloride ion concentration and sulphate ion concentration.
- The acceptable water quality standard is showed as below table.

PH value	Total hardness	Conductivity	Sulphate ion	Chlorine ion	Ammonia ion
7~8.5	< 50ppm	<200µV/cm(25°C)	None	< 50ppm	None
Sulfate ion	Silicon	Iron content	Sodium	Ca	
< 50ppm	< 50ppm	< 0.3ppm	No requirement	< 50ppm	

- Suggest the filter meshes is about 40 meshes.

CHECKING THE ANODE & REPLACING IF REQUIRED

(Frequency: Every Half Year - Replace if required)

The anode protects the inner lining of your hot water tank. When the anode become degraded the level of protection is diminished. It is recommended that anode is periodically checked for its level of degradation and gets replaced if required.

- Turn off the power and turn off the cold water inlet valve.
- Open a hot water tap and decrease the pressure of the inner container.
- Open the drain port and exhaust the remaining water completely in the release about 20L water.
- Remove the top cover by removing the locking screw and rotating in a clockwise direction.
- Release the front casing, disconnect the display cable from the electrical compartment and put aside.
- Locate the anode position on the left hand side.
- Remove the anode cover by releasing the two screws.
- Unscrew the anode and lift directly up.
- Check for degradation.
- If still in suitable condition, refit ensuring an effective seal
- If anode is in an unsuitable condition, replace with a new one, ensuring an effective seal.

PLUMBING CONNECTIONS

- Reopen the cold water inlet valve.
- Open a hot water tap until hot water flows out, then turn off the hot water tap.
- Turn on the power to restart the unit.
- Now the unit can be used as normal.

CLEANING THE INNER TANK AND ELECTRIC HEATING ELEMENT (FREQUENCY: EVERY HALF YEAR)

It is recommended to clean the inner tank and electric heating element regularly to maintain efficient performance.

- Turn off the power.
- Close the cold water inlet valve & open a hot water tap.
- Use a flexible pipe to connect the drain port to a suitable sewage drain. (Note: The min. heat resistance of the drain pipe must not be less than 93°, if the drain pipe does not meet the requirement, please open the cold water inlet valve & open a hot water tap, until the temperature of the water is suitable for the drain pipe).
- Open the drain port of the water heater; drain out all the water in the inner tank. If it is needed, use water to wash the inner tank several times to clear the deposits.
- Close the drain port, re-fill the inner tank with water, and turn the power back on.

FILLING THE SYSTEM:

- Once the system has been connected in accordance to Section 3.0 and 4.0 of this handbook, the tank can be filled and pressurised.
- Open the non-return valve on the cold-water inlet to begin filling the system with water. At the same time, ensure at least one hot water tap is open inside the property. While the system begins filling with water you will hear air being expelled from the open hot water tap. This is called "bleeding the system" and it ensures that no air pockets remain. Once water begins running out of the hot water tap, the system is completely bled, and you can then turn the tap off.
- Always ensure the tank is completely full before connecting and turning on the electricity supply.

ELECTRICAL CONNECTIONS

WARNING

- The electrical connections must be completed by a qualified and trained professional.
- The circuit must be connected to a reliable earth electrode connected to the consumer unit.
- The testing of the circuit and final connections are the responsibility of the trained installer.

PRE-CONNECTION & REGULATIONS

- When connecting the unit, electrical work must comply with the local supply authority regulations as well as AS3000.
- The power rating of the unit is set at 10 amps as such the mains power supplying the unit must have a 10 amp minimum circuit breaker fitted.
- Note this device is fitted with an over-temperature control cut-out. Under no circumstances must the water heater be in operation without this safety device connected to the circuit. Re-setting and replacement of this device must only be carried out by a qualified electrical contractor.
- (AS/NZS 60335-1 Clause 7.12.2): disconnection must be incorporated in the fixed wiring in accordance with the wiring rules.
- FUSE: 260V, 16A
- Unit power supply circuit must be ground, power supply wire and external grounding reliable connection, and the external grounding is effective.
- Wiring must be constructed by the professional installation technicians in accordance with the circuit diagram.
- Power line and signal line layout should be neat, reasonable, can not interfere with each other, but not with the connecting pipe and the valve body contact.
- The unit is not matching the power line, please supply specifications refer to provisions, does not allow the wires connecting.
- After all wiring construction is completed, please carefully check it before switch on the power supply.
- If the supply cord is damaged, it must be replaced by either the manufacturer, a service agent or similarly qualified person to avoid a hazard.

ELECTRICAL CONNECTIONS

WIRING DIAGRAM

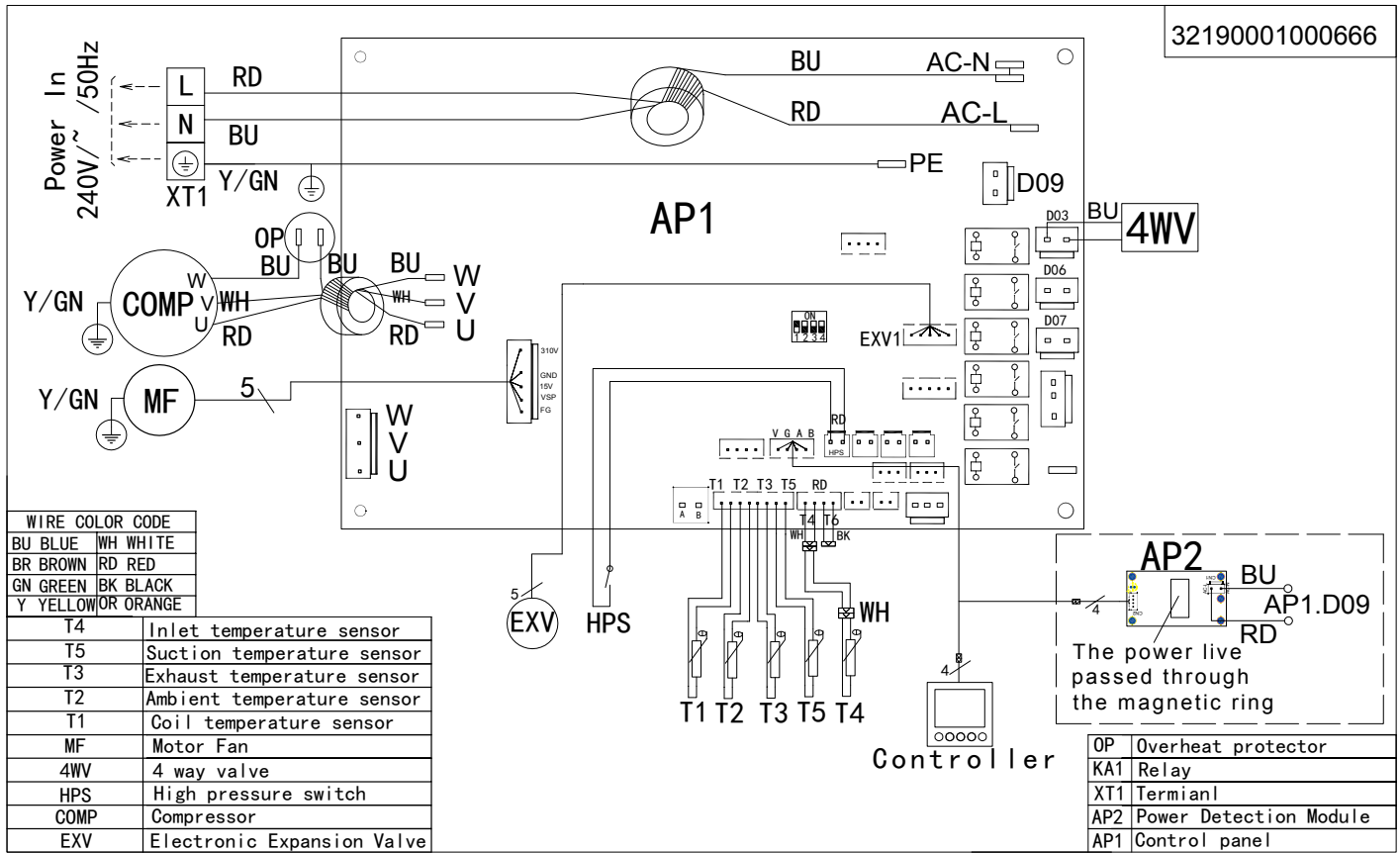



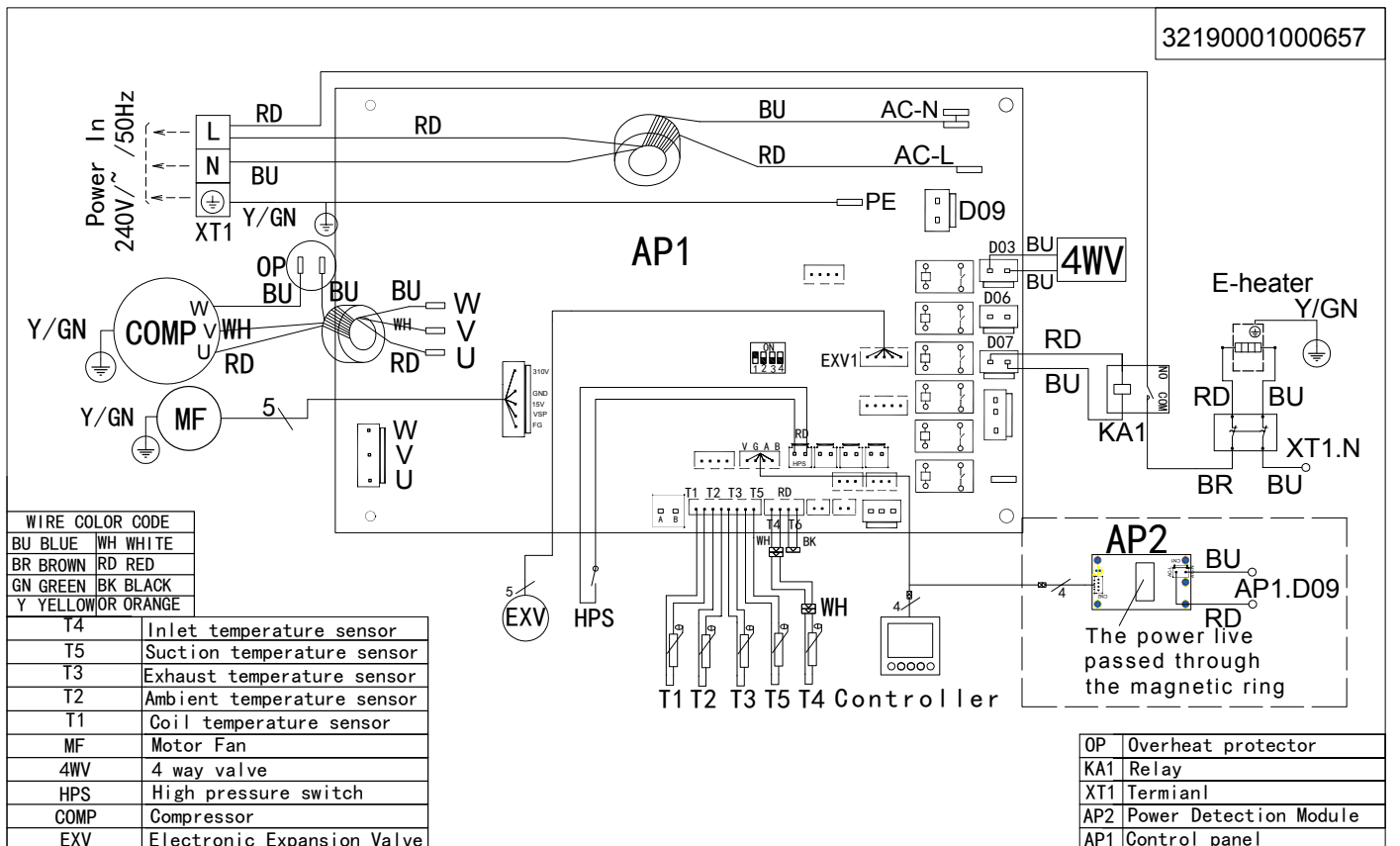

EE-HWS-A1-220(-1) & EE-HWS-A1-270(-1)



EE-HWS-A1-220E(-1) & EE-HWS-A1-270E(-1)

CONTROLLER INSTRUCTIONS

BUTTON INSTRUCTIONS

	On/Off Button	<ul style="list-style-type: none"> Press this button for 3 seconds to unlock the controller; Press this button for one second to turn ON/OFF system; In Query status, press this button to return to the main interface; In Setting status, press this button to return to the main interface
	Running Mode	When the system is turned on press this button to select different running mode;
	Up & Down	<ul style="list-style-type: none"> Press UP or DOWN button quickly at main interface to set target water temp. Press UP or DOWN button for 3 seconds to enter the query state. Under back end parameter setting status, press the UP or DOWN button to adjust setting value. Under Timer or Clock setting status, press the UP or DOWN button to adjust setting value
	Clock & Timer Setting	<ul style="list-style-type: none"> In the main interface, press this button shortly to enter the real clock setting, and press this button again shortly again to switch the real time setting area "hour" and "minute". In the main interface, press this button for 3 seconds to enter/exit the timer period setting or mode. In the main interface, press this button for 3 seconds to enter/exit the timer period. Under timer setting status, press this button shortly to switch the timer setting area "hour" and "minute". Under timer setting status, press this button for 3 seconds to cancel the timer setting. Under clock setting status, press this button to activate/deactivate weekly function

ICON INSTRUCTIONS

SYMBOL	STATUS	DESCRIPTION
	Constantly Bright	System is under standard mode
	Constantly Bright	System is under silent mode
	Constantly Bright	System is under booster mode
	Constantly Bright	System is under defrost
	Constantly Bright	Service required
	Constantly Bright	Compressor is running
	Constantly Bright	Fan motor is running
	Constantly Bright	Electric heating element is on for heating (only for the models with element)
	Flashing	Electric heating element is on for sterilization (only for the models with element)
RT	Constantly Bright	Current water temperature in the tank
SET	Constantly Bright	Set target water temperature in the tank
	Display	Display actual water temperature, set water temperature, and fault code
°C	Constantly Bright	Currently showing Celsius temperature
	Display	Show clock time
	Display	Timer is on
ON	Display	Timer function is activated
OFF	Display	Timer function is deactivated
1	Constantly Bright / Extinguished	Timing period 1 set / Timer period 1 not set
2	Constantly Bright / Extinguished	Timing period 2 set / Timer period 2 not set
3	Constantly bright / Extinguished	Timing period 3 set / Timer period 3 not set
	Constantly Bright	The controller is locked
	Constantly Bright	The Wi-Fi is connected

CONTROLLER INSTRUCTIONS



OPERATION INSTRUCTIONS

CONTROLLER LOCK AND UNLOCK



1. In the locked state, press the button  for 5 seconds, the buzzer will beep once, then the controller is unlocked;
2. The controller gets locked automatically when no operation for 60 seconds;

SELECT RUNNING MODE





STANDARD MODE:

- Press the  button to switch to Standard mode. Under this mode, the  icon lights up;
- The setting range is optional with 15°C - 63°C for target water temperature;
- Heat pump would be running with the most efficient way;
- If the heat pump fails, the electric heating element would be automatically activated, and the water would be heated up to the target water temperature;



SILENT MODE:

- Press the  button to switch to Booster mode. Under this mode, the  +  + icons light up. The setting range is optional with 15°C - 60°C for target water temperature;
- Heat pump would be running with lower noise (lower running frequency)
- If the heat pump fails, the electric heating element would be automatically activated, and the water would be heated up to the target water temperature.
- This is a one shot function and will return to standard mode after one cycle.









3) BOOSTER MODE:

- Press the  button to select Booster mode. Under this mode, the  +  +  icons light up.
- The setting range is optional with 15°C - 70°C for target water temperature for the model EE-HWS-A1-220E(-1) and EE-HWS-A1-270E(-1), and 15°C - 60°C for the model EE-HWS-A1-220(-1) and EE-HWS-A1-270(-1);
- Heat pump would be running with bigger heating capacity (bigger running frequency)
- If the target water temperature $\leq 60^{\circ}\text{C}$, both the heat pump and electric heating element work simultaneously during the entire heating cycle;
- If the heat pump fails, only the electric heating element heats the water up to the target water temperature.
- This is a one shot function and will return to standard mode after one cycle.

WATER TANK TEMPERATURE SETTING

In the case of power on and unlocking, press the  or  button on the main interface to adjust the water temperature setting value of the water tank.













REAL TIME CLOCK SETTING

1. In the main interface, press the  button shortly to enter the real-time clock setting
2. In the real-time clock setting interface, press the  key once, and the number of the hour part will flash. At this time, press the  or  button to set the hour of the real-time clock;
3. After setting the hour, press the  button again, the number in the minute part flashes, press the  button at this time or , the minute of the real-time clock can be set;
4. After the minute part is set, press the  button again to confirm the current clock setting and return to the main interface;
5. In the real-time clock setting interface, if there is no operation for 60 seconds, confirm the current real-time clock setting value and return to the main interface;
6. In the real-time clock setting interface, press the  button to confirm the current real-time clock setting value and return to the main interface.

CONTROLLER INSTRUCTIONS

OPERATION INSTRUCTIONS (CONTINUED)

TIMER SETTING





1. On the main interface, press the  button for 3 seconds to enter the setting interface of the timer periods;
2. At this time, press the  or  button to set the timing 1, 2, and 3 periods;
3. When the No. 1 segment is flashing regularly, press the  button to enter the setting interface of the hour part of the timing power-on of the timing period 1. The number in the hour part of the timing start time flashes, at this time press the  or  button, you can set time;
4. After setting the hour part of the timed start-up, press the  button again, it represents the minutes of the timed start-up time. Part of the numbers flashes, at this time, press the  or  button to set the minutes of the timing 1 period;
5. After setting the minutes for the time 1 period to turn on, press the  button again to enter the hour setting for the time 1 period to turn off, the setting method is the same as above;
6. After setting the timing shutdown time, press the  button to confirm the current set timing shutdown time. Enter the power-on/off settings of the timing period 2, the setting method is the same as that of the timing period 1, and return to the main interface after the setting is completed;
7. If the fixed on and off times are set to be the same, the timing will be canceled;
8. In the timing interface, if there is no key operation for 60 seconds, confirm the current set timing and return to the main interface (It can be remembered when power off after timing);
9. In the timing interface, press the  button to confirm the current set timing and return to the main interface.

MEMORY FUNCTION AND OTHER FUNCTIONS





1. The power-down memory function is on the chip of the remote controller;
2. The back light will be on when there is an operation, and after no operation, the back light will be off after 1 minute;
3. When there is a communication failure, the main board cannot work;
4. In the boot mode, only the current mode, water tank temperature, and time are displayed. When there is a load output, the corresponding symbol is displayed, and other unused functions are not displayed.

MANUAL STERILIZATION

ONLY AVAILABLE FOR THE MODELS WITH ELECTRIC HEATING ELEMENT

1. Press and hold the  +  +  for 5 seconds to enter the manual disinfection state;
2. The  symbol lights up, indicating that it has entered the disinfection state, start the electric heating to heat the water to 75°C and maintain the water temperature between 73°C - 75°C. After 30 minutes later, it will automatically exit the disinfection state, and the  symbol will go out.
- 3) Only available for the models with electric heating element

FORCED DEFROSTING

1. In the power-on state, press the  +  button for 5 seconds to enter the forced defrosting (the coil temperature must be lower than the exit defrosting temperature to enter the forced defrosting Enter), the  icon lights up during forced defrosting.
2. When shutdown or forced defrosting reaches the set time or temperature, the system automatically exits forced defrosting and enters normal heating water status, the  icon goes out during forced defrosting.





3.9 ELECTRIC HEATING ELEMENT CONTROL

ONLY FOR EE-HWS-A1-220E(-1)& EE-HWS-A1-270E(-1)

1. When defrosting, electric heating element is forced to be turned on if heating is required; The electric heating element is not allowed to be turned on within 60 seconds after the machine is powered on or after the electric heating element is turned off.
2. When the ambient temperature is $\leq 2^{\circ}\text{C}$, the heat pump will be not allowed to be turned on, and the electric heating element is automatically activated to produce hot water. When the ambient temperature $\geq 5^{\circ}\text{C}$ The electric heating is stopped.
3. When high pressure protection or exhaust high temperature protection occurs, the compressor will be locked off, and the electric heating element is automatically activated to produce hot water.
4. When exhaust temperature sensor failure, coil temperature sensor failure, gas return temperature sensor failure, the electric heating element will be automatically activated on above conditions, which is not restricted by the ambient temperature requirement;

CONTROLLER INSTRUCTIONS

CHECK HEAT PUMP SYSTEM RUNNING READINGS

1. In the main interface, press the  or the  button for 3 seconds to enter the running status query interface. The controller will show the code number and corresponding running value.
2. Press the  or the  button to check different running readings.
3. See below table about running readings.

CODE	DESCRIPTION	RANGE
1	Compressor running frequency	0~150Hz
2	Fan running frequency	0~999Hz
3	EEV opening	0~480P
4	AC input voltage	0~500V
5	AC input current	0~50.0A
6	Compressor phase current	0~50.0A
7	Compressor IPM temperature	-40~140°C
8	Ambient temperature T2	-40~140°C
9	Evaporator coil temperature T1	-40~140°C
10	Gas suction temperature T5	-40~140°C
11	Gas exhaust temperature T3	0~150°C
12	Tank water temperature T4	-40~140°C
13	4 way valve	0=OFF,1=ON
14	Electric heating element	0=OFF,1=ON
15	High pressure switch	0=OFF,1=ON

ERROR CODE LIST

ERROR CODE	DESCRIPTION
E05	High pressure switch failure
E09	Communication failure between controller and main board
E12	Gas exhaust temperature too high
E15	Water tank temperature sensor failure
E16	Evaporator coil temperature sensor failure
E18	Gas exhaust temperature sensor failure
E21	Ambient temperature sensor failure
E29	Gas suction temperature sensor failure
E35	Compressor current over high protection
E38	Fan motor failure
E44	Low ambient temperature protection
E88	Compressor driver board failure (See appendix 1)
E96	Communication failure between compressor driver board and main board (detected by main board)
E98	Communication failure between fan driver board and main board (detected by main board)

CONTROLLER INSTRUCTIONS

APPENDIX 1: COMPRESSOR DRIVER BOARD FAILURE

The system will stop running immediately once the driver board fails. The error code E88 and below code would appear.

P1	Bit0: IPM over current/IPM module protection
P2	Bit1: Compressor fails to be driven/Software control abnormal/Compressor out of step
P3	Bit2: Compressor over current
P4	Bit3: Input power supply lack of phase(not for single phase)
P5	Bit4: IPM current detection failure
P6	Bit5: Power component overheat to lead system shutdown
P7	Bit6: Pre-charge failure
P8	Bit7: DC bus over voltage
P9	Bit8: DC bus under voltage
P10	Bit9: AC input under voltage
P11	Bit10: AC input over current
P12	Bit11: AC input detection failure
P13	Bit12: Communication failure between DSP and PFC
P14	Bit13: Radiator temperature sensor failure for
P15	Bit14: Communication failure between DSP and communication board
P16	Bit15: Communication failure between main board and driver board
P17	Bit0: Compressor over current alarm
P18	Bit1: Compressor weak magnetic alarm
P19	Bit2: PIM overheat alarm
P20	Bit3: PFC overheat alarm
P21	Bit4: AC input over current alarm
P22	Bit5: EEPROM alarm;
P23	Bit6: NA
P24	Bit7: EEPROM refresh complete (disappear after restart);
P25	Bit8: Temperature sensor failure to lead frequency limit
P26	Bit9: AC under voltage alarm to lead frequency limit
P27	Bit10~Bit15:NA
P28	Bit0: IPM overheat to lead system shutdown
P29	Bit1: Compressor lack of phase
P30	Bit2: Compressor overload
P31	Bit3: Input current detection failure
P32	Bit4: PIM supply voltage failure
P33	Bit5: Pre-charge voltage failure
P34	Bit6: EEPROM failure
P35	Bit7: AC input over voltage failure
P36	Bit8: Micro electronic parts failure
P37	Bit9: Compressor model code failure
P38	Bit10: Bit11~Bit15: NA Over current detection (hardware detection)

NO.	DESCRIPTION	CAUSES
1	High pressure protection	1. Refrigerant over filling; 2. Blockage or air mixed in the refrigerant 3. Pressure switch failure 4. Fan doesn't work normally
2	Gas exhaust temp protection	1. Sensor failure or sensor connection wire failure 2. Lack of refrigerant or air mixed in the refrigerant 3. EEV opening abnormal 4. Fan doesn't work normally
3	Coil temp sensor failure	1. Sensor failure or sensor connection wire failure 2. Main board failure
4	Ambient temp sensor failure	Same as No.3
5	Return water temp failure	Same as No.3
6	Exhaust temp sensor failure	Same as No.3
7	Outlet water temp sensor failure	Same as No.3
8	Gas return temp sensor failure	Same as No.3

COMMISSIONING THE SYSTEM

ATTENTION

- Open the valve of water system, and the valve of assistant tank, inject water inside the system, and exhaust air inside.
- Do adjustment after electrical safety inspection.
- After the power is switched on, start the test running of heat pump, to see if it can function well.
- Forced operation is prohibited because it is hazardous to work without protection.

PREPARATION BEFORE ADJUSTMENT

- The system is installed correctly.
- Tubes and lines are putted in the right place.
- Accessories are installed.
- Ensure the smooth drainage.
- Ensure the perfect insulation.
- Correct connection of ground lead.
- The supply voltage can meet the requirement of rated voltage.
- Air inlet and outlet function can work well.
- Electrical leakage protector can work well.

ADJUSTMENT PROCESS

- Check if the switch of the line controller can work well.
- Check if the function keys of the line controller can work well.
- Check if the indicator light can work well.
- Check if the drainage system can work well.
- Check if the system can work well after starting up.
- Check if the water outlet temperature is acceptable.
- Check if there is vibration or abnormal sound when the system is functioning.
- Check if the wind, noise and condensate water produced by the system affect the environment around.
- Check if there is refrigerant leakage.
- If any fault occurs, please check the instructions first, to analyze and remove the fault.

COMMISSIONING THE SYSTEM

ATTENTION

- Open the valve of water system, and the valve of assistant tank, inject water inside the system, and exhaust air inside.
- Do adjustment after electrical safety inspection.
- After the power is switched on, start the test running of heat pump, to see if it can function well.
- Forced operation is prohibited because it is hazardous to work without protection.

PREPARATION BEFORE ADJUSTMENT

- The system is installed correctly.
- Tubes and lines are putted in the right place.
- Accessories are installed.
- Ensure the smooth drainage.
- Ensure the perfect insulation.
- Correct connection of ground lead.
- The supply voltage can meet the requirement of rated voltage.
- Air inlet and outlet function can work well.
- Electrical leakage protector can work well.

ADJUSTMENT PROCESS

- Check if the switch of the line controller can work well.
- Check if the function keys of the line controller can work well.
- Check if the indicator light can work well.
- Check if the drainage system can work well.
- Check if the system can work well after starting up.
- Check if the water outlet temperature is acceptable.
- Check if there is vibration or abnormal sound when the system is functioning.
- Check if the wind, noise and condensate water produced by the system affect the environment around.
- Check if there is refrigerant leakage.
- If any fault occurs, please check the instructions first, to analyze and remove the fault.

OPERATION AND MAINTENANCE

1. Personals shall possess professional knowledge or operate according to professionals from our company. To ensure the well functioning, the system shall be checked and maintained after a period of time. During the maintenance, please pay attention to some points below:

- Control and protect the equipment, please do not adjust any settings discretely.
- Pay close attention to whether all the operation parameters is normal during system working.
- Examine regularly whether the electrical connection is loose, if yes, fasten it on time.
- There will be calcium oxidized or other mineral substance deposition on the surface of water heat ex-changer copper coil after long period of operation, which will influence the heat exchange performance and lead to high electrical consumption, discharge pressure increasing and air suction pressure drop, unit hot water volume produced is less. We can adopt formic acid, citric acid, acetic acid or other organic acid to clean.
- The dirt retention on the surface of evaporator fin should be blown by more than 0.6Mpa compressor air, brushed by fine copper wire, or flushed by high pressurized water, usually one time per month; if too much dirt, we can use paintbrush dipping gasoline to clean.
- After long downtime, if we restart the equipment, we should make following preparations: examine and clean the equipment carefully, clean the water pipeline system, examine the water pump, and fasten all the wire connections.
- Replacement parts must use our company original accessories, can not be replaced by other similar accessories.

2. Refrigerant filling

Examine the refrigerant filling condition through reading the data of liquid level from display screen, also the air suction and exhaust pressure. If there is leakage or changing components of the refrigeration circulation system, we have to make air tightness examination first.

3. Leak detection and air tightness experiment:

During leak detection and air tightness experiment, never let the refrigeration system filling oxygen, ethane or other flammable harmful gas, we can only adopt compressed air, fluoride or refrigerant for such experiment.

4. To remove the compressor, please follow the following steps

- Turn off the power supply
- Exhaust the refrigerant from the low pressure end, attention to reduce the exhaust speed, and avoid frozen oil leakage.
- Remove the compressor air suction and exhausting pipe.
- Remove the compressor power cables.
- Remove the compressor fixing screws.
- Remove the compressor.

5. Conduct regular maintenance according to the user manual instruction, to make sure the unit running in good condition.

- **Fire prevention:** if there is a fire, please turn off the power switch immediately, put out the fire using fire extinguisher.
- **To prevent flammable gas:** the unit working environment should stay away from gasoline, ethyl alcohol and other flammable materials, to avoid explosion accident.
- **Malfunction:** if malfunction occurs, should find out the reason, eliminate it and then reboot the unit. Never boot the unit forcibly if the malfunction has not been eliminated. If refrigerant leakage or frozen liquid leakage, please turn off all the power switch, if the unit can not stop buy controlling switch, please turn off the general power switch.
- Never short connect the wire for protection required device, or else, in case unit malfunction, it can not be protected normally and will damage the unit.

AFTER SALES SERVICE

If your hot water heater can not operate normally, turn off the unit and cut off the power supply at immediately.

Contact your service center or technical department.

WARRANTY INFORMATION

Emerald Energy Pty Ltd warrants this heat pump to the original purchaser.

Emerald Energy Pty Ltd warrants each new heat pump is free from defects in material and workmanship under normal use and service from the date of purchase. 2 year labour warranty. 7 years warranty on the tank, and 5 years on the rest of the system. *Subject to terms and conditions.

This warranty does not cover damage resulting from accident, misuse or abuse or lack of reasonable care of the product.

In no case shall Emerald Energy Pty Ltd be liable for any incidental or consequential damages for breach of this or any other warranty express or implied whatsoever.

For full warranty details visit our website emerald-energy.com.au

Emerald Energy Pty Ltd

ABN 86 632 172 368

12a Rodborough Road Frenchs Forest NSW 2086

2023.05