



OWNERS MANUAL

Mar 24

- ✓ Australia's No.1 selling hot water heat pump
- ✓ High quality, efficient and energy saving
- ✓ Industry leading technology and innovation



BOOSTER
ELEMENT



ECOGENICA
INNOVATION MEETS TECHNOLOGY

EG_OWNERS MANUAL
FRFREC_MAR_24

- EG-330FRE/C
- EG-290FRE/C
- EG-260FR/C
- EG-215FRE/C

About the **Ecogenica® FRE/FREC** Range



ECOGENICA
INNOVATION MEETS TECHNOLOGY

Designed and developed in Australia for Australian conditions, the Ecogenica® range of direct heat transfer water pump heaters offer ground-breaking technology to deliver energy efficient hot water savings to Australian homes and businesses.

The All-In-One Models

The following Product Manual relates to both Split and All-in-One model. See page 24 for the All-In-One models EG-260FR & EG-260FRC.

The Split Range

The **Ecogenica® EG-215FRE & EG-215FREC, EG-290FRE & EG-290FREC and EG-330FRE & EG-330FREC** models are, quick connect heat pumps using the most advanced reverse cycle heating technology which directly heats the water.

Our range of heat pumps utilise cold R290a natural gas, which absorbs heat energy wind, rain or shine, as it passes through the large heat pump fin coil.

The piping hot water is stored in a vitreous enamel lined steel cylinder and in extreme situations the water at the top of the tank is also heated by the electric immersion heating unit.

The upper thermostat controls the element activation and automatic safety controls are fitted to the water heater to provide safe and efficient operation. An additional mid-point sensor controls the heat pump activation. The intelligent controller then ensures that the water is maintained at a constant temperature even in the harshest conditions.

The temperature sensors and protective over temperature cut out, ensure safe and highly energy efficient hot water production, there is no need to switch the water heater off, or adjust settings, even when it is not in use. The Heat Pump is fully automatic, and power is only used when heating is required.

With fewer moving parts - no circulation pumps or troublesome heat exchangers - maintenance is required less often, making the FRE model range a more reliable and resilient design compared to other heat pump water heaters.

The FRE range of heat pumps operate with exceptional energy efficiency, with a COP of up to 5.

A Coefficient Of Performance (COP) of 5 means that for every 1kW of power used from the grid, (or from your solar power system), the Heat Pump provides 5kW hot water heating!



FEATURES

- **Australia's most energy efficient Hot Water Heat Pump** -up to 80% energy savings
- **Powerful Heat Pump** - fast hot water production = lots of hot water at a lower price
- **Direct heat transfer condenser tank** - greater reliability & less maintenance
- **Easy to install**
- **Slim line tank design** - fits into narrow areas

Index

Reference	Performance & Specifications	Page 4
Warnings	Safety Information	Page 5
	Notice to Customer	Page 6-7

For all Models

1 Before Installation	Page 8
2 System Debugging	Page 9

SPLIT QUICK CONNECTION MODELS: EG-215FRE/C & EG-290FRE/C & EG-330FRE/C	Page 10
---	----------------

3 Components and Connections	Page 11-13
4 Electrical Circuit Diagram	Page 14
5 Installation	Page 15-18
6 System Troubleshooting	Page 19-21

ALL-IN-ONE CONNECTION MODELS: EG-2600FR/C	Page 22
--	----------------

7 Warnings	Notice to Customer	Page 23-24
8 Connections		Page 25
9 Electrical Circuit Diagram		Page 26
10 Installation		Page 27-30
11 System Operation		Page 31
12 System Troubleshooting		Page 32

For all Models

13 System Maintenance	Page 33-34
14 Warranty	Page 38-39

Reference: Performance & Specifications

Performance of the FRE & FREC Models Easily compare features to choose the right model for you.

Model	EG-330FRE/C	EG-290FRE/C	EG-260FR/C	EG-215FRE/C
Energy Saving*	75.60 %	80.70 %	74.70 %	79.00 %
Suitable for number of rooms	3 to 6	3 to 5	3 to 4	2 to 3
Recovery Rate** Litres/hour	99	80.6	70	67.7
No of People suitable for	2-8 People	2-7 People	2-5 People	2-3 People

All temperature is measured in 20 degrees Celsius, water temperature rise 40 degrees Celsius.
Quantity showers @ 40 degrees /35 litres/ shower/hour.

* Energy Savings are at 55 degrees Celsius. Energy Savings noted are for Residential models (i.e. EG-330FRE). Commercial (C) models heat to 65 degrees Celsius and efficiency decreases at higher temperature.

** Recovery rate is 40 degrees temperature rise / 20 degrees ambient / 55 degrees water temperature. Recovery rates at 6 degrees are less than nominal recovery rates.

Specifications of the FR, FRC FRE & FREC Models

Model	EG-330FRE/C	EG-290FRE/C	EG-260FR/C	EG-215FRE/C
Tank Volume	330 L	290 L	260 L	215 L
Input Power	1020 W	750 W	670 W	630 W
Heat Pump Heating Capacity	4600 W	3750 W	3250 W	3150 W
Booster Electric Element Heat Capacity	4800 W	3600 W	3600 W	3600 W
COP	4.51 W/W	5.0W/W	4.85 W/W	5.0 W/W
Fittings	20mm / G 3/4	20mm / G 3/4	20mm / G 3/4	20mm / G 3/4
Tank Size	330	290	260	215
Tank Dimensions	Height	1815 mm	1850mm	2115 mm
	Width	620 mm	570 mm	600 mm
Heat Pump Dimensions	Height	610 mm	545 mm	Built
	Width	840 mm	780 mm	onto
	Depth	313 mm	276 mm	Tank
Heat Pump Max Current	7.0 A	5.0 A	5.0 A	4.5 A
Booster Electric Element Heat Capacity	4.8	3.6	-	3.6
Power Supply	220-240V/50Hz	220-240V/50Hz	220-240V/50Hz	220-240V/50Hz
Operating Temperature Range	-7°C ~+43°C	-7°C ~+43°C	-7°C ~+43°C	-7°C ~+43°C
Refrigerant Type	R290	R290	R290	R290
Protection Ranking Class	IPX4	IPX4	IPX4	IPX4
Connection	Split Quick	Split Quick	All-in-one	Split Quick

Test Conditions:

1. Default setting +55°C
2. Outlet Water Temperature +55°C
Inlet Water Temperature +14°C
Dry Bulb Temperature +19°C
Wet Bulb Temperature +15°C

NOTES:

- EG-215FRE/C, EG-290FRE/C and EG-330FRE/C models are split and come with Pre-Charged One Shot Couplings for ease of installation by a plumber.
- Split Quick Connection models (EG-215FRE/C, EG-290FRE/C and EG-330FRE/C) only require standard plumbing connections, heat pump is located on top of tank.
- All-in-one Connection models (EG-260FR/C): refrigeration connections are factory welded.
- Gas: R290 is a natural gas, or natural refrigerant, otherwise known as propane.
- Plumbers will need a gas fitters license to handle Split Quick Connection models (EG-215FRE/C, EG-290FRE/C and EG-330FRE/C).

COMMERCIAL MODELS:

**EG-215FREC, EG-260FRC,
EG-290FREC and EG-330FREC.**

Parameters are the same as above with slight differences in dimensions.. Commercial models have a higher set temperature. Please contact us for details on commercial installations.



Warning: Safety Information

Please read all manuals carefully before installing and operating this unit. The following safety warnings are very important, always read and obey all safety signs.



WARNING

- The device must be effectively grounded.
- RCBO circuit breaker must be installed.
- Do not remove, cover or damage any permanent instructions or labels from the exterior or interior of the unit panel.
- Only qualified personnel should install in accordance with local and national regulations and this guide.
- Improper installation may cause water leakage, electric shock or fire alarm.
- All electrical connections must comply with the requirements of the local power company, the local power company and this guide.
- Do not use rated fuse, otherwise it may malfunction and cause electrical fire.
- Do not insert fingers, rods or other objects into the air inlet or outlet. The fan is rotating at high speed, which may cause injury.
- Do not use flammable sprays, such as hairspray or paint, near the machine to avoid fire.

- **Disposal:** Do not dispose of electrical appliances as unsorted municipal waste. A separate collection facility should be used. Contact your local government to find out information about the collection system. If electrical appliances are disposed of in landfills or dump sites, hazardous substances can seep into groundwater and cause health problems.

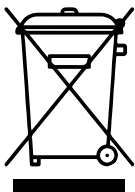

- The unit must be fixed firmly, otherwise noise and vibration may be generated.
- Make sure there are no obstacles around the device.
- In places with strong wind (such as seaside areas), the unit should be installed in a windproof place.
- The PTR valve should be operated every 6 months to ensure that the valve does not have any restrictions. The drain pipe should be well insulated to prevent the water in the pipe from freezing in cold weather.

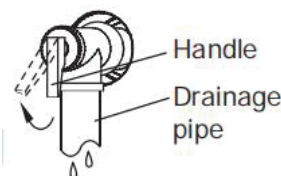

CAUTIONS

- The ground electrode must be well grounded. Make sure all electrical sockets and plugs are dry and tightly connected;
- Before cleaning, be sure to stop operation and isolate the unit (ie, turn off the isolating switch or circuit breaker). Otherwise, electric shock and injury may occur;
- Water temperature over 50 degrees Celsius will cause severe burns and even death. Children, the disabled and the elderly are at the highest risk of burns. In the bath feel the water temperature with your hands before showering to avoid burns.
- Do not operate the machine with wet hands to avoid electric shock.
- A one-way check valve and a suitable isolation valve must be installed on the water inlet side.
- It is normal for the one-way safety valve to release some water during operation. However, if there is a large amount of water, please contact our service team. Improper drainage can cause water damage to surrounding areas such as buildings, furniture etc. Except for repair and maintenance purposes, do not turn off the power, especially in cold weather, as it may freeze the machine when the power is turned off. Continuously powered heating water is necessary.



Do not puncture the water heater casing, do not smoke, or activate sparking of any description within 1.5 meters of this water heater. Compliance with national gas regulations should be observed. This water heater contains flammable propane refrigeration in a sealed closed refrigeration circuit..





Warning: Notice to Customer

This air source water heater must be installed and maintained by licensed professionals in accordance with building regulations.

Only licensed professionals will issue you a certificate of compliance certifying that the work in question meets all relevant standards, and only licensed professionals will take out craft insurance.

If a safety tray is required to prevent building damage, construction, installation and draining of a safe tray must comply with AS/NZS 3500.4 and all local codes and regulatory authority requirements.

The water heater must be maintained in accordance with the Owner's Guide and Installation Instructions. As this system contains R290 (propane) care must be taken to ensure the system is installed in accordance to AS/NZS 60335.2.40:2019 - Household and similar electrical appliances. Please consult with Eco Alliance about internal installations.

The installation conforms to the Plumbing Code of Australia (PCA).

The water heater must be maintained in accordance with the Owner's Guide and Installation. instructions.

As the refrigerant is R290 (propane) care must be taken to ensure the system is installed in accordance to AS/NZS 2712 and must meet the following conditions:

- Complies with A60335.2.40:2019 - Household and similar electrical appliances.

The installation conforms to the Plumbing Code of Australia (PCA).egulations of the local authority;

- in line with national building regulations;
- local occupational health and safety regulations;

Please read and understand this manual.

Warning: - If the hot water system is not in use for a number of weeks a quantity of hydrogen gas may accumulate in the Water Heater. To dissipate the gas safely please turn on the hot water tap for several minutes to ensure that gas has been properly removed from the water heater. As the air escapes sometimes sounds accure, this is normal.

Hot water burns!

For safety, small children should be supervised around hot water appliances. Heat pump water heaters can store water at temperatures that cause scalding, and water temperatures over 50 degrees Celsius can cause scalding, so care must be taken to ensure that damage is not caused by improper use of the water heater.

Since heat pump water heaters can generate water temperatures more than +50 degrees Celsius, regulations require that a regulating valve be installed on the hot water outlet line of the water heater to prevent the water temperature from exceeding a pre-set safety upper limit. When installing or retrofitting an existing system, the installation must be performed by an authorized plumber.

Care should be taken to avoid contact with any plumbing or fixtures associated with the water heater plumbing. Under no circumstances should "home craft" type modifications be attempted.

This appliance is not intended for use by persons (including children) with reduced physical sensory or intellectual abilities, or who lack the experience and knowledge to safely use this appliance without supervision or instruction. Children should be supervised by a responsible person to ensure their personal safety.

Warning

This unit requires reliable earthing before use, otherwise this may result in injury or death.





Warning: Notice to Customer *(continued)*

Circuit Breaker

The hot water pump power supply must be protected by a separate circuit breaker on the main power switch board and rated to suit the size of the components.

Do not connect other appliances, especially high-power appliances, to the main power supply of the water heater, so as not to affect the normal use of the water heater.

WARNING – For continued safety of this appliance it must be installed, operated and maintained in accordance with the manufacturer’s instructions.

WARNING – This appliance may deliver water at high temperature. Refer to the Plumbing Code of Australia (PCA), local requirements and installation instructions to determine if additional delivery temperature control is required.

Anode

It’s essential to replace the anode, when necessary, as the anode is installed in your water heater to protecting the cylinder, but it will slowly wear out over time. It is recommended that you replace the anode during a five-year service, or before if you have poor water quality in your area, the maximin time between replacement is 8 years. Poor water quality occurs when water supplies that are either softened, desalinated, or where the water supply alternates between a water tank and a public supply or another source. Typically, a magnesium anode is fitted as the standard option. During anode replacement the correct selection of the anode is crucial to maintain the warranty on the water heater cylinder. We recommend you refer to the Anode Selection Chart for correct anode selection.

Anode Selection Chart

Total Dissolved Solids Anode Colour Code

Condensation Drain

Installers need to firstly put the tank and condenser in place. The installer needs to work out the best layout strategy for the pipe and consider all site issues before lowering the condenser pipes. Place the device on a flat, firm surface capable of bearing the weight of the device. If there is no special drainage pipe (sink), be sure to ensure that the condensed water flowing on the ground can be drained smoothly to avoid water pooling around the heat pump. As condensate will otherwise drip from the appliance onto the floor if the drainpipe is not added. The outdoor unit (Heat Pump) is installed with a 25mm high rubber shockproof, and it is firmly fixed with studs to avoid noise when the machine is running.



P&T Value Drain Line

A drain line from a relief valve must comply with the requirements of AS/NZS 3500.4. The drain lines from the temperature pressure relief valve and expansion control valve from an individual water heater may be interconnected if approved by local regulations. The termination point of a drain line must comply with the requirements of AS/NZS 3500.4. And the outlet of a drain line must be easily seen, and arranged so discharge will not cause injury, damage, or nuisance.

For all Models

1 Before Installation

1.1 UNPACKING

When unpacking, make sure that the items in the accessories list are complete, and that the model of the main unit and the water tank are correctly matched.

1.2 TRANSPORT

When shipping this item, the following rules must be followed:

When moving, do not make the fuselage deviate from the vertical angle by more than 25 Degrees. Keep vertical.

To avoid scratches or damage, please use protective covering where applicable. Since the machine is heavy, it needs two or more people to carry it, to avoid injury and/or damage.

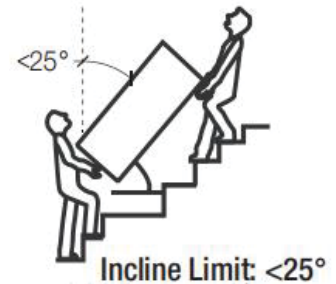

1.3 POSITION REQUIREMENT

When choosing a suitable location, the following factors should be considered:

- Ensure that there is enough space for installation and future maintenance,
- The inlet and outlet should be free of obstacles and strong winds,
- The bottom surface should be flat (i.e., no more than 2° inclination), and capable of bearing 3 times the weight of the machine, while ensuring that no noise and/or vibration will be increased. Securely secure the device to help avoid unnecessary noise and/or vibration,
- The running noise and the exhausted airflow should not affect other people,
- Make sure there is no flammable gas nearby.

Installation indoors is not recommended and permission must be secured from Eco Alliance, as this unit contains propane, which is a flammable gas. Ensure that the electrical insulation complies with the relevant local standards. Do not install inside a building if not compliant with Australian Standard: AS/NZS 60335.2.40, (2023) - Household and similar electrical appliances.

If the device must be installed in the metal part of the building, it should be ensured that the electrical insulation complies with the relevant local standards.



CAUTIONS

- The ambient air temperature must also be taken into account. The heat pump operates at ambient air temperature between -7°C and +40°C, below or above this range, the heat pump will not operate.
- If it is installed in closed spaces such as garages and basements, there must be unrestricted air flow (such as installing a strong exhaust fan) to ensure that the temperature is not lower than the specified range of the machine to prevent freezing. Installing this unit in any of the following locations may cause malfunction (consult your representative before purchasing).
 - Mineral oil (eg lubricant for cutting machines).
 - Hot spring areas with corrosive gases (eg sulfides).
 - Factories with large voltage fluctuations.
 - In a cabin without a large enough exhaust system.
 - Areas where flammable gases or materials are present.
 - Areas where acidic or alkaline gases are present.
 - Other special environments.

For all Models

2 System Debugging

2.1 PREPARATION BEFORE OPERATION

Operation without water in the water tank may cause the water heater to enter a protection state, which may damage components in severe cases. In the event of such damage, the manufacturer will not be responsible for any damage caused by this issue. Before trial operation, please follow the steps below:

1 Trial run must be done after all installations are complete.

2 Before starting the machine, please confirm the following items (at right), and mark them in the box after confirmation.

- Correct installation,
- Piping and wiring are correct,
- Drainage and emptying are smooth without leakage,
- Plumbing installed correctly,
- The power supply voltage is consistent with the rated voltage of the unit,
- The air inlet and outlet of the unit are barrier-free,

2.2 TURN ON POWER CAUTIONS

Before turning on the power to the unit, double-check that the water tank is full of water.

- After confirming that the power cord is firmly connected, turn on the power of the water heater.
- No need to operate the display, the display is in the power-on state by default.
- The device has a three-minute delay start function, please be patient.

After running for 30 minutes, observe the running status, if there is any problem, please check the display. If there is a fault code displayed on the screen contact us with timely feedback.

- The device is fully automatic control, according to the selected method and the surrounding environment, the set water temperature, self-adaptive adjustment, and heating the stored water to target temperature.

2.3 MACHINE RUNNING DYNAMICS

There are different heating times at different ambient temperatures.

Typically lower ambient temperatures result in longer heat times and therefore performance.

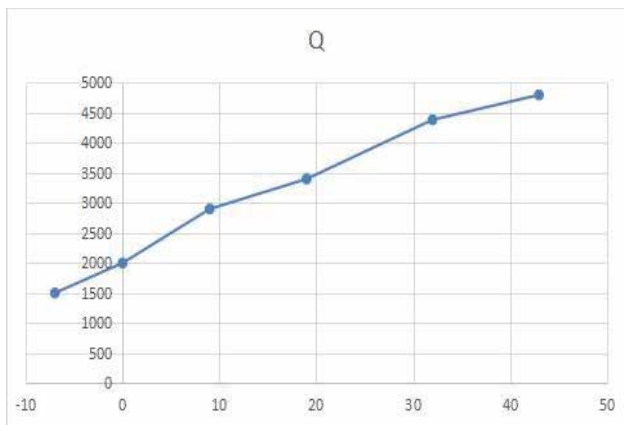

Changes in ambient temperature and heating capacity

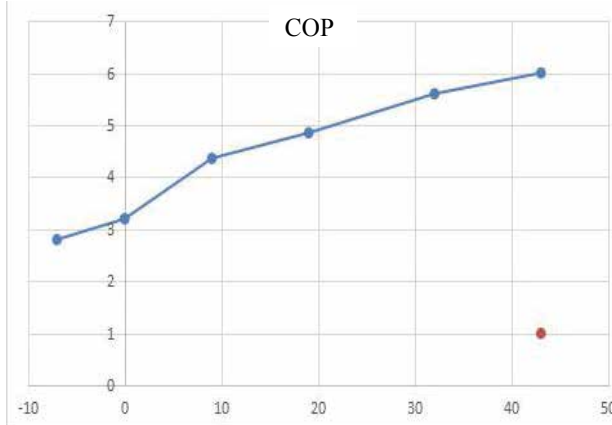

Changes in ambient temperature and energy efficiency ratio

2.4 PRODUCTION METHOD

When the self-protection mode is activated, the system will stop and start self-checking. Once the error is resolved, the unit will restart. When the self-protection mode is activated, the error code will be displayed on the screen until the error is resolved.

The device can enter self-protection mode under various conditions, including but not limited to:

- blocked air inlet or outlet;
- The evaporator is covered with too much dust;
- The unit receives incorrect power (over the 220-240v range).

2.5 REFRIGERANT ADDITION

Please contact Eco Alliance or Ecogenica for instructions and approval. Only use R290 natural-refrigerant.

Split Quick Connection Models

EG-215FRE/C

EG-290FRE/C

EG-330FRE/C



3 Heat Pump Components

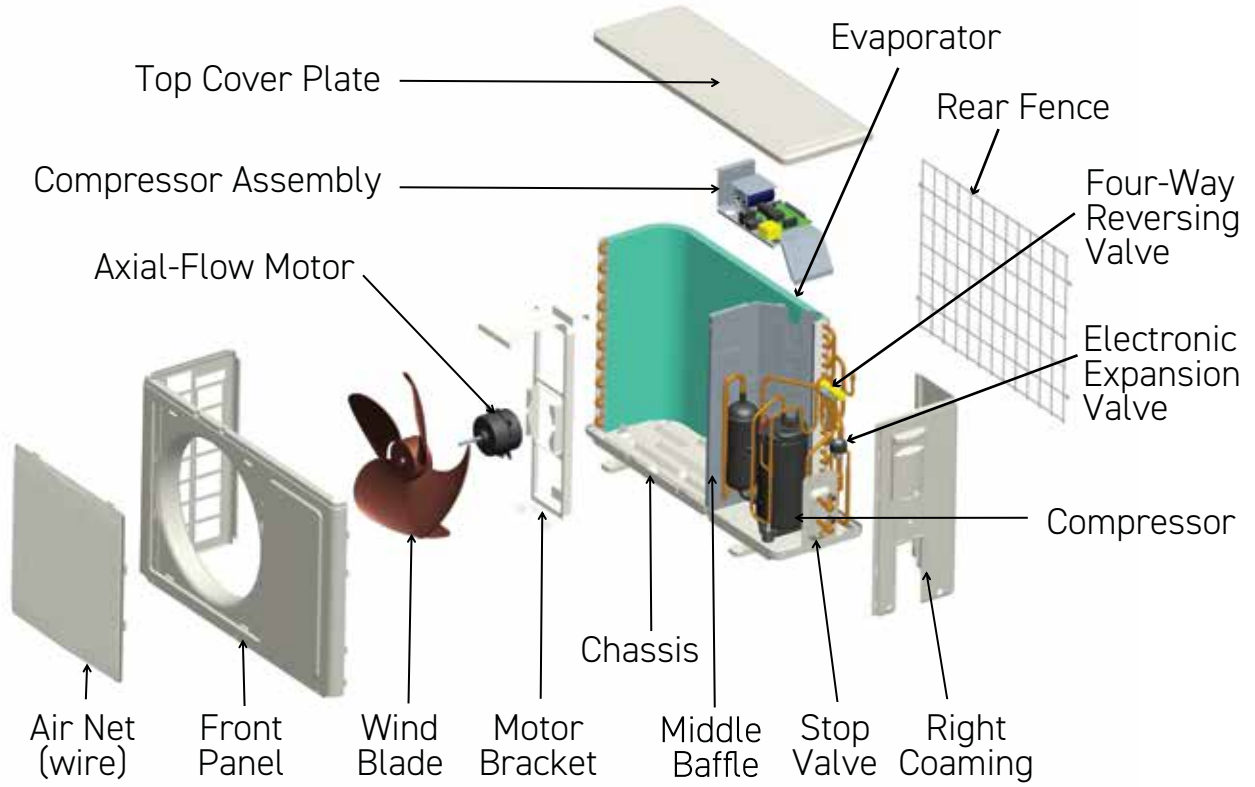

3 Water Tank Connections and Dimensions

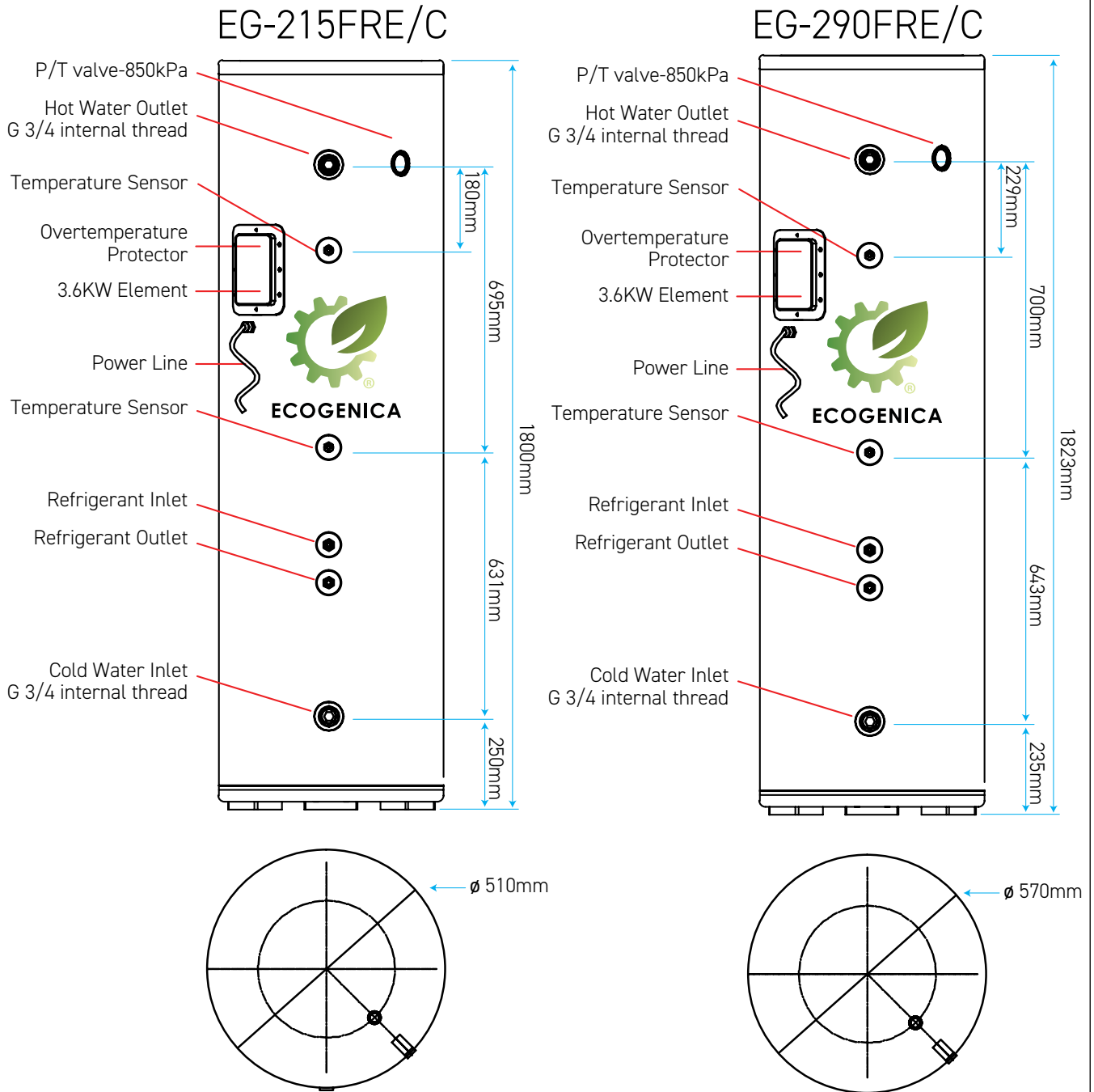

3 Water Tank Connections and Dimensions

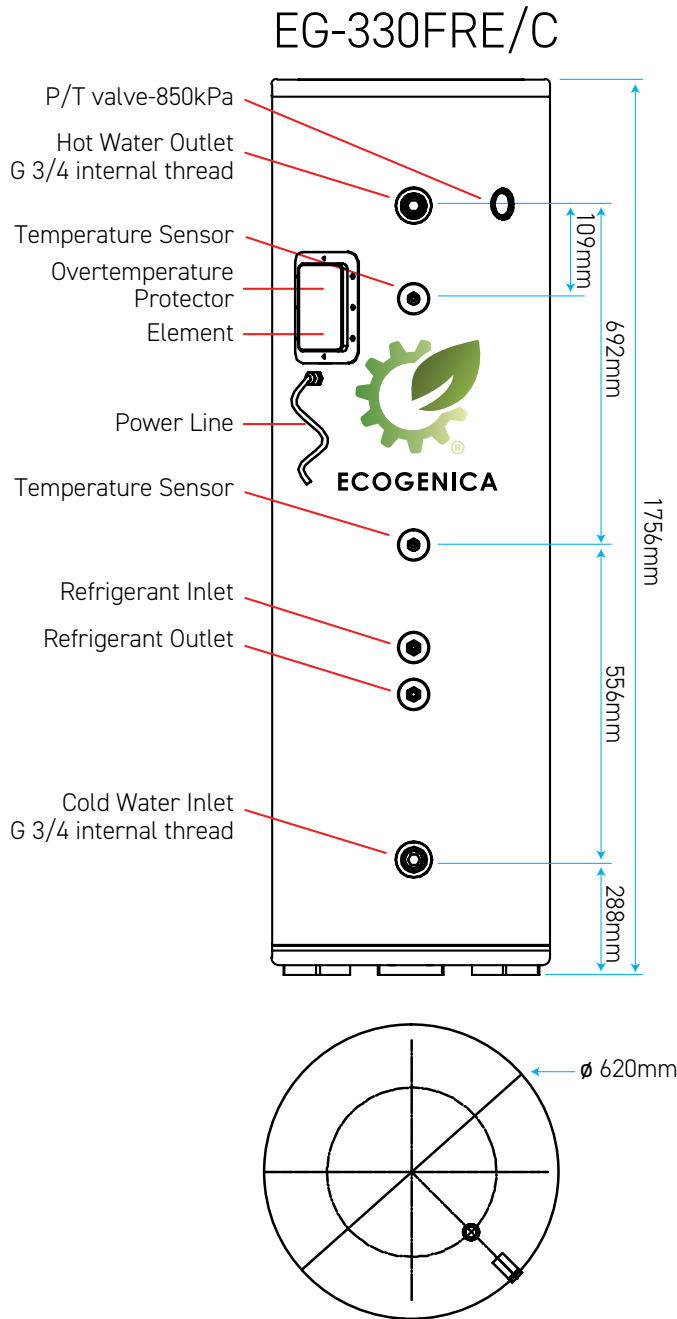

All piping should be compliant to the Australian plumbing code and Standard AS/NZS 3500.4:2021, Section 2.5.2 Lagging must be applied to pipes and valves for at least the first 500 mm in all directions, including PTR drainpipes, for at least the first 500mm and it is best practice plumbing to ensure external hot water pipework to the primary kitchen sink is lagged.

Drains from the water heater must be directed away from the building, fall continuously, discharge water away from the operator during the operation of the valve, not pose a risk to people (AS/NZS 3500.4:2021) and be insulated for at least the first 500mm. PTR drains must use copper piping.

4 Electrical Circuit Diagram

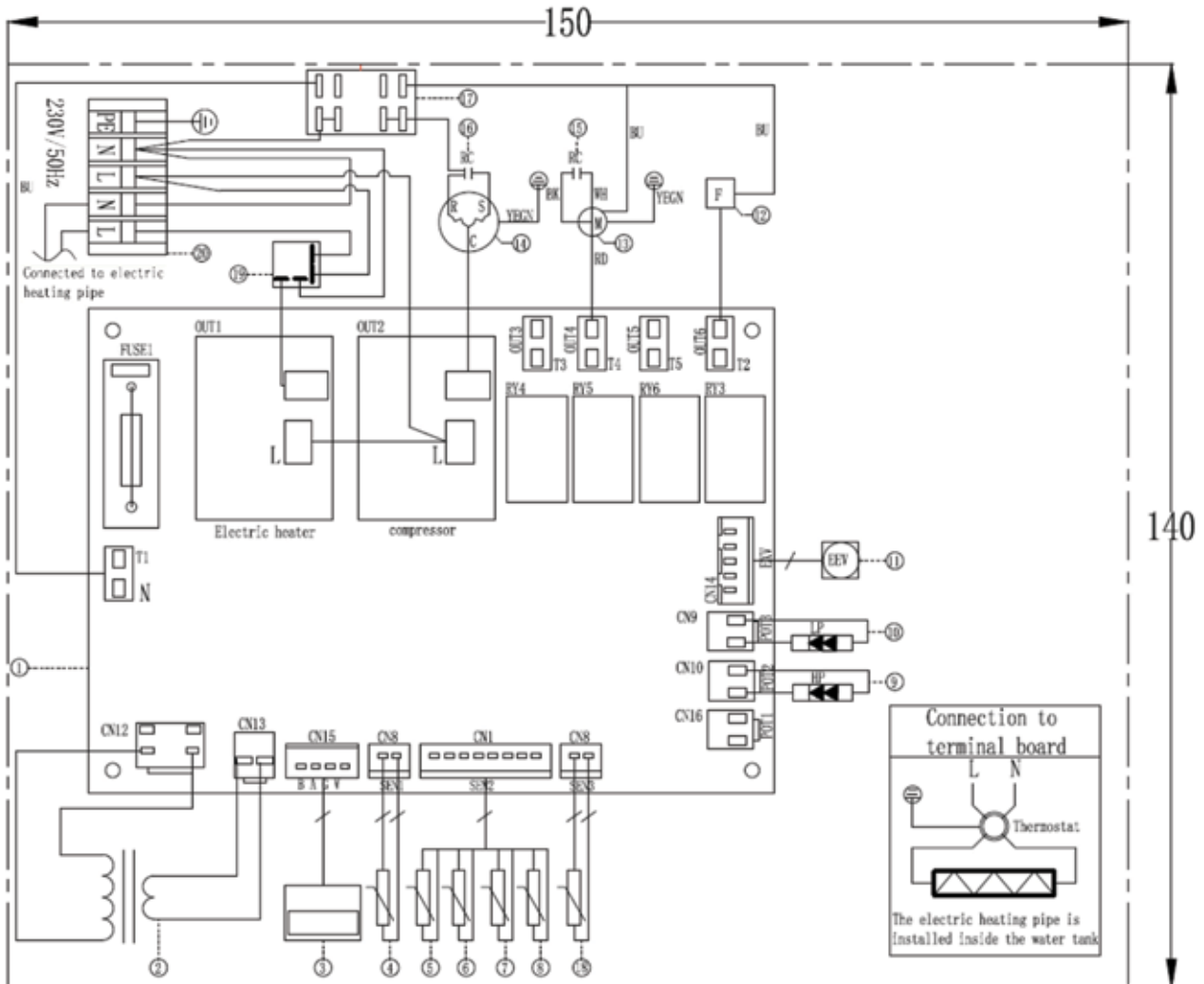

- | | |
|--|--|
| 1 - Integrated Circuit Board | 12 - Four-way Reversing Valve |
| 2 - Transformer | 13 - Motor |
| 3 - Displayer | 14 - Compressor |
| 4 - Water Tank Temperature Sensor (T1) (central section) | 15 - Motor Capacitance |
| 5 - Exhaust Temperature Sensor | 16 - Compressor Startup Capacitor |
| 6 - Ambient Temperature Sensor | 17 - Connection Terminal Station |
| 7 - Gas Recovery Temperature Sensor | 18 - Water Tank Temperature Sensor (T2) (upper part) |
| 8 - Coiler Temperature Sensor | 19 - Electric Heating Relay |
| 9 - High Pressure Switch | 3.6KW Element: EG-215FRE/C & EG-290FRE/C |
| 10 - Low Pressure Switch | 4.8KW Element: EG-330FRE/C |
| 11 - Electronic Expansion Valve | 20 - Power Terminal Board |

5 Installation

5.1 PIPING CONNECTIONS

Cold water inlet and hot water outlet are 3/4 inch (20mm) female connections.

The outlet of the PTR valve is a 3/4 inch (20 mm) female fitting.

All hot water pipes must be insulated for safety and insulation.

- 1 - Cold Water Supply Outlet (20mm female thread)
- 2 - Connecting Pipe
- 3 - Water Temperature Sensor (lower)
- 4 - Water Temperature Sensor (upper)
- 5 - Hot Water Supply Outlet (20mm female thread)
- 6 - PTR Relief Valve (15mm female) (800kPa)
- 7 - Isolation Valve
- 8 - Pressure Reduction Valve (800kPa)
- 9 - One-way Valve (non-return)
- 10 - Thermostatic Valve
- 11 - Isolation Valve
- 12 - Element

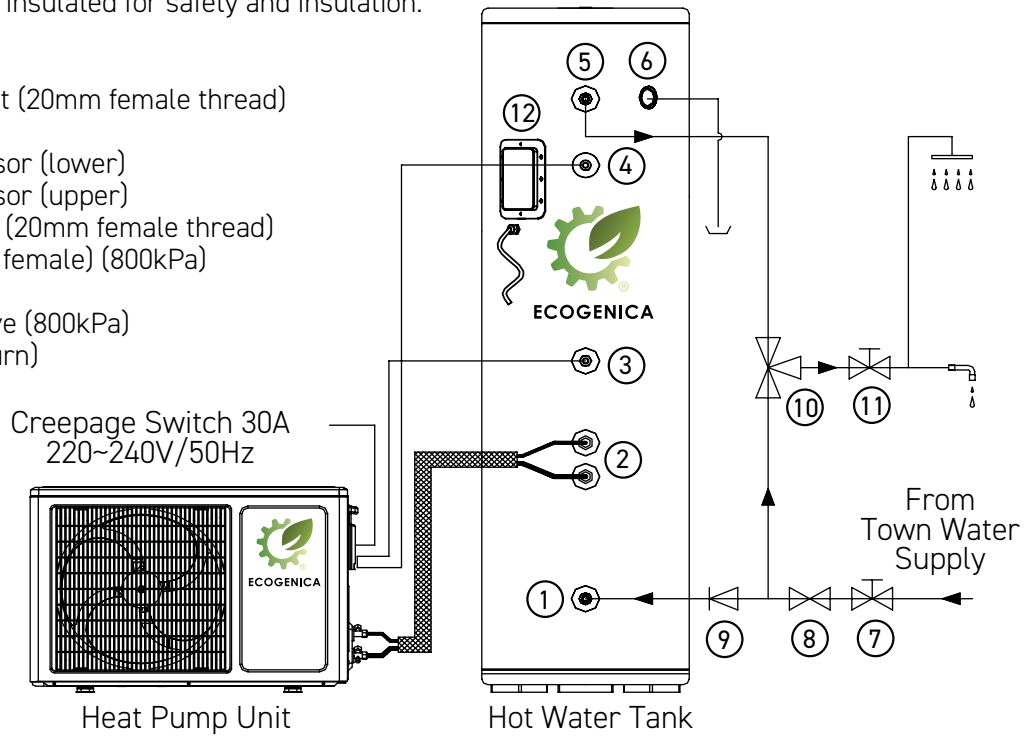

WARNING

During the use of the machine, the PTR Valve needs to be manually operated. If there is water flowing out, it is considered that the PTR Valve is in normal use. otherwise, the PTR Valve needs to be replaced (be careful of burns).

During the use of the machine, a small amount of water will leak out at the outlet of PTR Valve, which is normal, but drainage treatment must be done regardless.

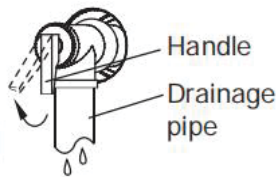

CAUTIONS

- If the outdoor temperature is lower than 5 degrees Celsius during installation, insulation protection must be provided for hydraulic components (ie pipes).
- If the water inlet pressure is less than 200 kPa, a booster pump should be installed at the water inlet.
- To ensure the safe use of the water tank, when the water inlet pressure exceeds 500 kPa, a pressure reducing valve must be installed on the water inlet pipe.

WARNING

- **Do not disassemble the PTR valve.**
- **Do not block the condensate drain line.**

5 Installation *(continued)*

5.2 HEAT PUMP UNIT INSTALL POSITION

1. Place the device on a flat, firm surface capable of bearing three (3) times the weight of the device.
2. Install as per diagrams at right ensuring adequate air circulation. Do not pile up obstacles within 2m from the air outlet, as this will affect the smooth air circulation. You should also avoid the windward direction.
3. If there is no special drainage pipe (sink), be sure to ensure that the condensed water flowing on the ground can be drained smoothly. The Condensate Drain is located at the base of the heat pump and it must be directed away from building footings.
4. We recommend to keep children away from the heat pump.
5. The outdoor unit is to be installed with rubber shockproofing, and it is to be firmly fixed to studs, to avoid noise or fall off when the machine is running.

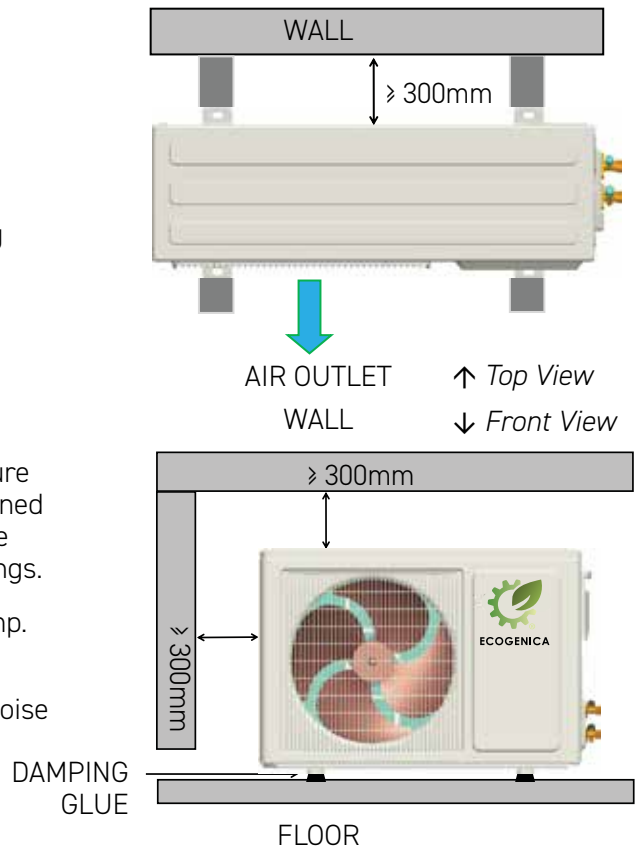

5.3 WATER TANK INSTALL POSITION

1. The water storage tank must be placed upright on the ground, with a 10cm foot pad under it. The installation site must have a solid foundation and must be able to withstand a weight of more than 500kg.
2. The hot water is NOT to be hung on the wall.
3. Normally the water storage tank is installed outdoors, Permission from the manufacturer must be secured, in writing, for internal installations. Use a fixing bracket to secure the hot water heater. If exposed to extreme wind, use bolts and a brace to firmly prevent damage from extreme weather.
4. It's important to ensure that no air locks exist in the hot water line. When filling the water tank open the isolation inlet valve, make sure that a tap is open, within in the home, to ensure that water comes out of the tap at full capacity tank.

5.4 REFRIGERATION PRE-CHARGED COUPLING

According to the installation site, the distance between the water heater and the water storage tank should not be greater than the length of the connecting pipe (the standard length of the connecting pipe is 2 metres). The FRE Series come standard with pre-charged 2 metre refrigeration lines for ease of Installation and to prevent leaks.

Remove the packaging and carefully lower the refrigeration lines towards the heat pump.

Connect the pre-charged refrigeration pipes using the (3/8" to 1/4") quick connect adapter supplied with the unit (in the quickie kit). Guide the refrigeration line onto the female refrigeration quick connect adapter and tightly screw the male coupling to the female coupling until the diaphragm is pierced. The single one-shot coupling is folded back into the coupling providing a high flow path and low pressure drop for the refrigeration charge in the condenser pipe (located on the water tank) to combine with the heat pump charge. Using an Allen Key, let the refrigerant into the system. Open both the high and low-pressure valves on the outside condenser. Open them all the way out, which will take several turns.



Once the couplings are connected a refrigeration charge in the condenser pipe is released into the heat pump and the fully charged heat pump is ready for plumbing connections.

5 Installation *(continued)*

5.5 WATER SYSTEM INSTALLATION

For water pipeline installation, please refer to above diagram

1. The selection of pipe materials, stainless steel pipes, copper pipes, hot water aluminum-plastic pipes, hot water PPR pipes, etc. can be selected in line with national health and safety standards. Pipes must be accurate, heat-resistant, rust-proof, and not easy to climb.
2. Install a one-way valve at the water inlet of the water tank as shown in the diagram below.
3. The connection between the water tank and the water pipe must be equipped with a shut-off valve or a removable joint for use in maintenance.
4. The arrangement of the water pipes is reasonable, and the bending is minimized to reduce the resistance of the water system.
5. For metal pipes, high-density flame-retardant PE sponge must be used for thermal insulation.

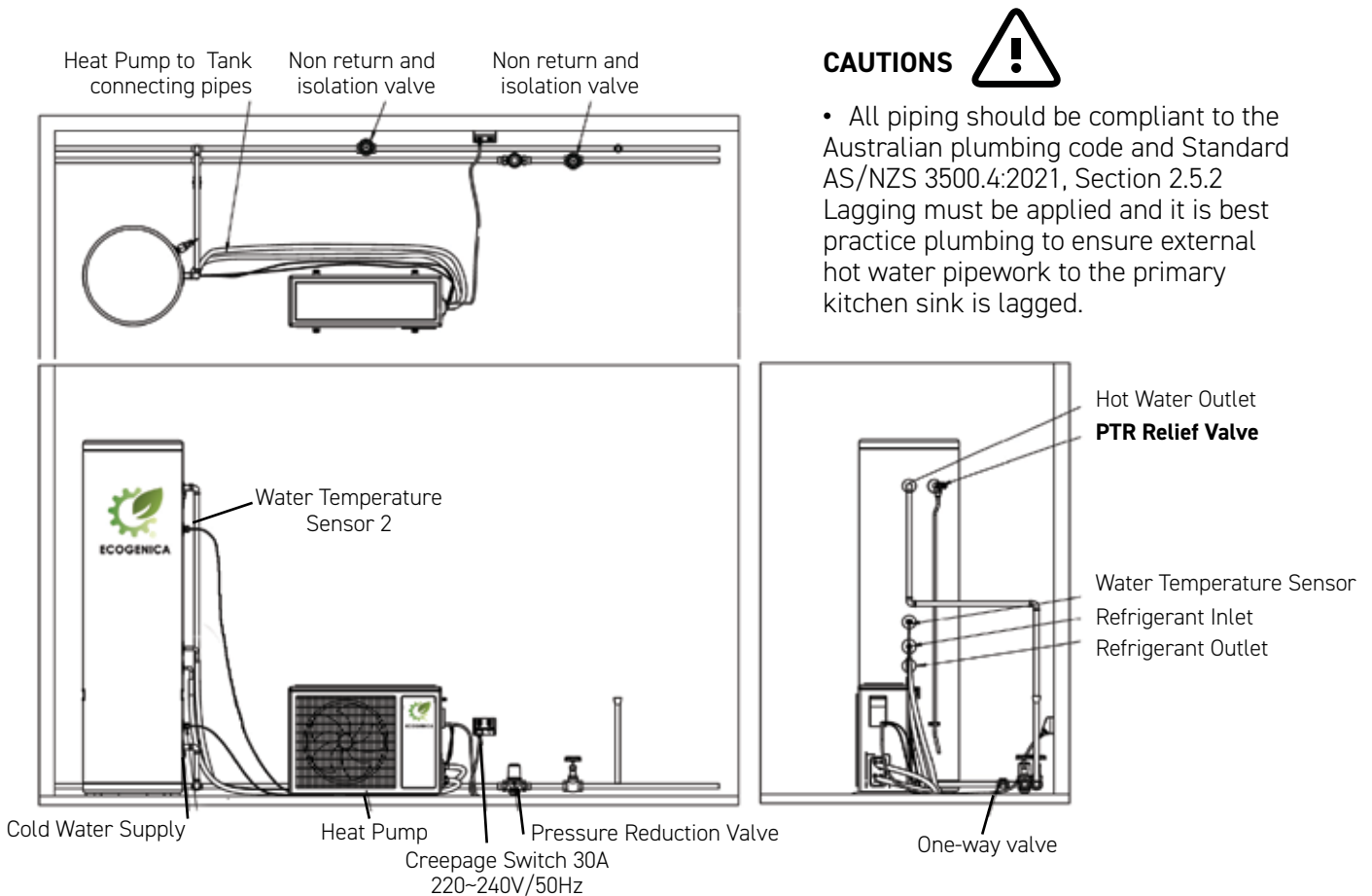

CAUTIONS

- All piping should be compliant to the Australian plumbing code and Standard AS/NZS 3500.4:2021, Section 2.5.2 Lagging must be applied and it is best practice plumbing to ensure external hot water pipework to the primary kitchen sink is lagged.

Drains from the water heater must be directed away from the building, fall continuously, discharge water away from the operator during the operation of the valve, not pose a risk to people (AS/NZS 3500.4:2021) and be insulated for at least the first 500mm. PTR drains must use copper piping.

Lagging / Thermal Insulation

Required R value to be achieved will depend on where in Australia the system is located, as a guide:

5 Installation *(continued)*

5.6 ELECTRICAL CONNECTIONS

Power Requirements

Check the markings on the rating plate of the water heater to be certain the available power supply corresponds to the water heater requirements. The Heat Pump Water Heater must be directly connected to a 230V-240VAC 50Hz mains power supply.

The water heater Heat Pump must be installed on separate individual circuits with a breaker switch installed directly at the switchboard. The power supply circuit of the machine must have an effective ground wire, and the power ground wire must be reliably connected to the external ground wire.

Power cables and signal cables should be arranged neatly and reasonably. Strong and weak cables should be separated from each other, and they should not interfere with each other. Otherwise, the normal state of the display will be affected. Please arrange the power supply layout reasonably and avoid splicing wires.

The appliance must be powered for the first time during the purge procedure after the tank was filled with water. in accordance with the relevant regulations on electrical safety and electrical wiring.

Solar Power

Contact Ecogenica to have our system set up for solar power timer activation

QUICK CONNECT INSTALLATION

- 1 Copper tubes ③ ④ are already welded to the tank and filled with refrigerant.
- 2 Please choose a correct position before connecting the copper tubes ③ ④ to condenser box.
- 3 Make sure the connector (male) is connected to the connector (female).
Please use a hexagon spanner to open-up the refrigerant valve.
- 4 Please check and make sure there is no refrigerant leak.

- 1 and 2 - Cover
- 3 - 9.52 \varnothing copper tube (2m)
- 4 - 6.35 \varnothing copper tube (2m)
- 5 - Connector (female) 1/4
- 6 - Connector (female) 3/8
- 7 - Connector (male) 1/4
- 8 - Connector (male) 3/8
- 9 - Hexagon spanner

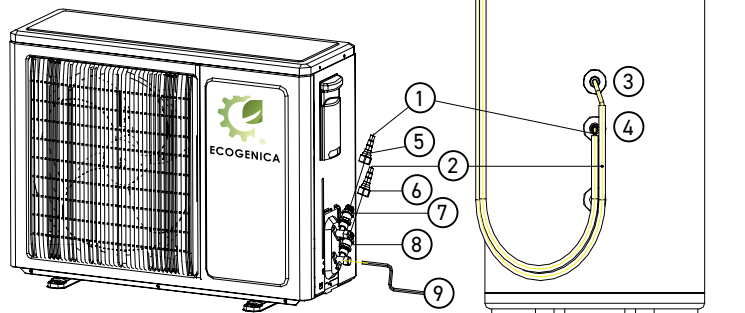

Plumbers – Best Practice is required please conduct the following check list before you finish and ensure that Valves easily accessible and all drainage doesn't damage buildings. Check your drains and piping for the following:

1. Drains are directed away from building footings.
2. Fall continuously from the valve to the point of discharge.
3. Does not pose a risk of injury to people.
4. The drain line discharges water away from the operator during the operation of the valve
Refer to AS/NZS 3500.4:2021 Section 5.11,
5. Copper piping is used, and you cannot use plastic pipes for drain lines
(AS/NZS 3500.4:2021, 2.5.2 (g))
6. The drain lines are insulated for at least the first 500mm, note that these drains are still considered an "outlet" according to the definitions in the standards.

6 System Trouble Shooting

6.1 FAULT CODES

	CONTENT	FAULT CODE	HEAT PUMP STATUS	NOTES
1	Freeze Protection	A11	-	-
2	Low Voltage Switch Protection	A12	Stop Heating	Power Off, then Power On
3	High Voltage Switch Protection	A13	Stop Heating	Power Off, then Power On
4	Water Tank Temperature Sensor Failure	A21	Stop Heating	Automatic Recovery
5	Coil Temperature Sensor Failure	A22	-	Automatic Recovery
6	Exhaust Temperature Sensor Failure	A23	-	Automatic Recovery
7	Ambient Temperature Sensor Failure	A25	-	Automatic Recovery
8	Intake Air Temperature Sensor Failure	A26	-	Automatic Recovery
9	Operator Cable Interruption Protection	A51	Stop Heating	When the VCC and GND lines are opened, the operator does not light up. When the A and B lines are opened, the operator displays the A51 fault code
10	Exhaust Temperature High Temperature Protection	A61	Stop Heating	3 times/hour, the heat pump stops working

6.2 TROUBLE SHOOTING

PROBLEMS	REASON	SOLUTION	PHENOMENON
Freeze Protection A11	When the water temperature is $\leq 4^{\circ}\text{C}$ for more than 5 minutes or ambient temperature is $\leq 2^{\circ}\text{C}$ and the shutdown time exceeds 15 minutes	Make sure the water volume of the water tank, the machine will automatically detect and return to normal	
Low Voltage Switch Protection A12	1. The terminals of the low-voltage switch fall off or have poor contact or are damaged	1. Check the circuit board port	After 3 occurrences within 1 hour, the machine will automatically stop working, and it needs to be powered on again to resume the re-detection
	2. Lack of snow seeds 3. The ambient temperature is lower than -7°C . The electronic expansion valve is not open	2. Check whether the operating pressure is lower than the standard value of the pressure switch; 3. The working environment has exceeded the limit operating range of the compressor. Check whether the electronic valve coil and port are loose;	

6 System Trouble Shooting *(continued)*

6.2 TROUBLE SHOOTING

PROBLEMS	REASON	SOLUTION	PHENOMENON
High Voltage Switch Protection A13	<ol style="list-style-type: none"> 1. The terminal of the high-voltage switch has fallen off or is in poor contact or is damaged 2. Water shortage (the pump does not work) 3. The filter is blocked 4. The electronic expansion valve is not opened. The water tank temperature sensor is not placed in the water tank, resulting in a misjudgment, which does not match the actual water temperature 	<ol style="list-style-type: none"> 1. Check the port of the circuit board 2. Check the amount of water or whether the pump is Work 3. Enter the forced defrosting function, reverse the flush for 1min 4. Check the coil and end of the electronic valve Whether the mouth is loose 	After 3 occurrences within 1 hour, the machine will automatically stop working, and it needs to be powered on again to resume the re-detection
Tank Temperature Sensor A21	<ol style="list-style-type: none"> 1. Break or short circuit 	<ol style="list-style-type: none"> 1. Replace the sensor 	Machine stop working
Coil Temperature Sensor A22	<ol style="list-style-type: none"> 1. Break or short circuit 	<ol style="list-style-type: none"> 1. Replace the sensor 	The machine can run normally, but cannot enter or exit the defrost
Exhaust Temp. Sensor A23	<ol style="list-style-type: none"> 1. Break or short circuit 	<ol style="list-style-type: none"> 1. Replace the sensor 	The machine can run normally, but the high temperature protection fails
Suction Temp. Sensor A26	<ol style="list-style-type: none"> 1. Break or short circuit 	<ol style="list-style-type: none"> 1. Replace the sensor 	Machine works normally
Operator Cable Interruption Protection A51	<ol style="list-style-type: none"> 1. The connecting line of the operator is open or short-circuited 	<ol style="list-style-type: none"> 1. Replace the sensor 	When the VCC and GND lines are connected, the operator does not light up. When the A and B lines are connected, the operator displays the A51 fault code, and the machine stops working
Exhaust Temp. High Temp. Protection A61	<ol style="list-style-type: none"> 1. Lack of snow seeds. Water shortage (pump not working) 	<ol style="list-style-type: none"> 1. Check whether the system lacks refrigerant, check the system leaks and make up for them in time; Check the water volume of the water tank and whether the pump is running 	After 3 occurrences within 1 hour, the machine will automatically stop working, and it needs to be powered on again to resume the re-detection

6 System Trouble Shooting *(continued)*

6.2 TROUBLE SHOOTING

PROBLEMS	REASON	SOLUTION
Shows running, but not heating	<ol style="list-style-type: none"> 1. The compressor does not work (overload or burn out) 2. Four-way valve gasping 3. In the cooling state (defrosting), lack of snow seeds 	<ol style="list-style-type: none"> 1. Check whether the compressor line is loose and measure whether the resistance of the compressor main winding and auxiliary winding is normal; 2. Judgment of panting of the four-way valve, check if the temperature of the exhaust pipe is the same as the temperature of the intake pipe, it is regarded as a panting phenomenon. Judgment of cooling status: the water temperature continues to cool down; the fan continues to blow hot air
Heating, fan not running	<ol style="list-style-type: none"> 1. The motor capacitor is damaged, the motor is burned out or the power cord is loose 	Replace the motor or capacitor
Compressor is noisy	<ol style="list-style-type: none"> 1. Water shortage (the pump does not work), the temperature difference is too large 2. The compressor is fixed too tightly, and the rubbing vibration space is small, the operating voltage has exceeded the range of 198V~242V; 	<ol style="list-style-type: none"> 1. Ensure that there is sufficient water; 2. The distance between the control nut and the top of the compressor damping rubber. Increase the voltage regulator to ensure that the voltage is normal
Product is noisy	<ol style="list-style-type: none"> 1. The pipeline vibrates greatly. If the distance between the parts is too small, it is easy to cause collision and friction 	<ol style="list-style-type: none"> 1. Vibration-absorbing rubber is added to the pipe fittings. Adjust the distance between components and pipes
User temperature is low	<ol style="list-style-type: none"> 1. The amount of cold water mixed with water is large, and the output of hot water is small 	<ol style="list-style-type: none"> 1. Adjust the mixing valve to control the ratio output of hot water and cold water

The diagnostic codes and usage symptoms listed above are the most common, if the diagnostic codes listed above or other usage issues do not appear, please contact technical assistance.

All-in-one Connection Models

EG-260FR and EG-260FRC



The Ecogenica **EG-260FR** and **EG-260FRC** litre All in one Mains Pressure Heat Pump Hot Water Heater, offers a slim line design, with rapid hot water heating and exceptional energy efficiency. This model does not contain an electric heating element.

This water heater is designed for direct connection to mains water supply. In case the mains supply pressure exceeds 500kPa, a pressure limiting valve must be installed. A minimum water supply pressure of 200kPa is required to assure the effective operation of this water heater.

7 Warning: Notice to Customer

The manufacturer's warranty does not cover any damage or defect caused by improper installation, attachment or use for any type of accessories (other than those listed in this user manual) with this water heater. The use of unauthorised energy saving devices may shorten the life of the water heater and may endanger life and cause property damage. The manufacturer disclaims any responsibility for such loss or injury resulting from the use of such unauthorised devices. Check council laws for specific rules in relation to location requirements for this appliance.

Warning: – If the hot water system is not in use for a number of weeks a quantity of hydrogen gas may accumulate in the Water Heater. To dissipate the gas safely please turn on the hot water tap for several minutes to ensure that gas has been properly removed from the water heater. As the air escapes sometimes sounds occur, this is normal.

7.1 TEMPERATURE LIMITING VALVE

Eco Alliance Pty Ltd requires the installation of a temperature limiting device between the water heater and the hot water outlets in a bathroom or similar usage point to reduce the risk of scalding.

Additionally, a certified plumber may have the legal obligation to ensure the water heater installation meets the hot water delivery requirements listed in AS/NZS3500.4

7.2 LOCATION REQUIREMENTS

The water heater and water lines should be protected from freezing temperatures and highly corrosive atmospheres. Locate the water heater in a clean area as near as possible to the areas of the biggest hot water demand. Long uninsulated hot water lines can waste energy and water.

IMPORTANT - INDOOR INSTALLATION APPROVALS: Because this unit draws in ambient air to heat the water, when using the unit indoors, you must contact the manufacturer and seek written approval to ensure that the proposed installation meets Australian Standards and has sufficient clean air to operate correctly.

Place the water heater in such a way that clearance for proper servicing is considered (→section 3.7) namely for top cover removal, PTR valve access and anode rod removal and installation. Remember you may need to remove the entire unit later for servicing.



WARNING

This water heater SHOULD NOT be installed in an area with a corrosive atmosphere where chemicals or flammable liquids are stored or where aerosol propellants are released. When using indoors, because of natural air movement in a room or other enclosed space, these corrosive/flammable vapours can be carried from where they are being used or stored. Any electric arc drawn within the water heater's electronic controls can ignite these vapours, causing an explosion or fire, which may result in severe burns or death to those in range as well as property damage.



CAUTION

The heater should not be in an area where leakage of the tank or connection will result in damage to the area adjacent to it or to lower floors of the structure. In places where installation in such areas cannot be avoided, it is recommended that a suitable catch pan which adequately drains, be installed under.

7 Warning: Notice to Customer *(continued)*

This installation must comply with the requirements of the AS/NZ3500.4 and AS/NZS3000 standards and all additional local codes and regulatory authority requirements.

In New Zealand, the installation must comply with the clause G12 of the New Zealand Building Code. All packaging materials must be removed from the water heater prior to its installation.

7.3 REQUIRED CLEARANCES

There must be a 30cm vertical clearance, a 20cm min clearance between the inlet and the wall, and 100cm from the outlet grilles and walls, or barriers. This will ensure a proper air flow through the appliance and facilitate the service any time is needed.

7.4 APPLIANCE OPERATION

In case of possible direct exposure to strong wind, face the air outlet to the most protected area. The direct incidence of strong wind in the outlet grille during long periods may affect the performance of the heat pump increasing the heating times and the frequency of defrost cycles. The use of the noise reduction mode is not recommended in case of moderate or strong wind. Adjust the height to correctly align the appliance at the installation location.

To ensure the faultless operation, the unit must be installed vertically with a tilt no more than 1°, preferably in the direction of the condensate drain to favour the condensates drainage.



WARNING:

**Damage to external tank casing!
Do not tilt more than 20° without packaging.**



WARNING:

All plumbing work must be carried out by a qualified professional and in accordance with the Plumbing Standards AS/NZS3500.4 & local authority requirements.

7.5 INLET-OUTLET CONNECTIONS

Installation of the water inlet or outlet pipes: The water inlet and outlet thread are $\frac{3}{4}$ BSP (internal thread). Pipes must be heat resistant, durable and UV resistant (when doing outdoor installation). Installation of the pipe for PTR valve: The specification of the valve thread is $\frac{1}{2}$ BSP (internal thread). Note: one way valve must be installed at the inlet.

7.6 POWER REQUIREMENTS

Check the markings on the rating plate of the water heater to be certain the available power supply corresponds to the water heater requirements. The Heat Pump Water Heater must be directly connected to a 230V-240VAC 50Hz mains power supply.

The water heater Heat Pump must be installed on separate individual circuits with a breaker switch installed directly at the switchboard.

The appliance must be powered for the first time during the purge procedure after the tank was filled with water.

7.7 SOLAR POWER

The Heat Pump also comes with a Solar activation timer. Solar Power must be provided to the inverter and switch board, as per local regulations and Solar installation Standards. The timer ensures that the Heat Pump operates between daylight hours, to align with Solar Power production. Users of the Heat Pump should use the Application to engage Solar timer activation, or disengage the timer, if Solar Power isn't available, during rainy, or Winter Months, for example. For instruction on Solar Timer Activation see the Ecogenica website or contact Ecogenica directly.

8 Connections

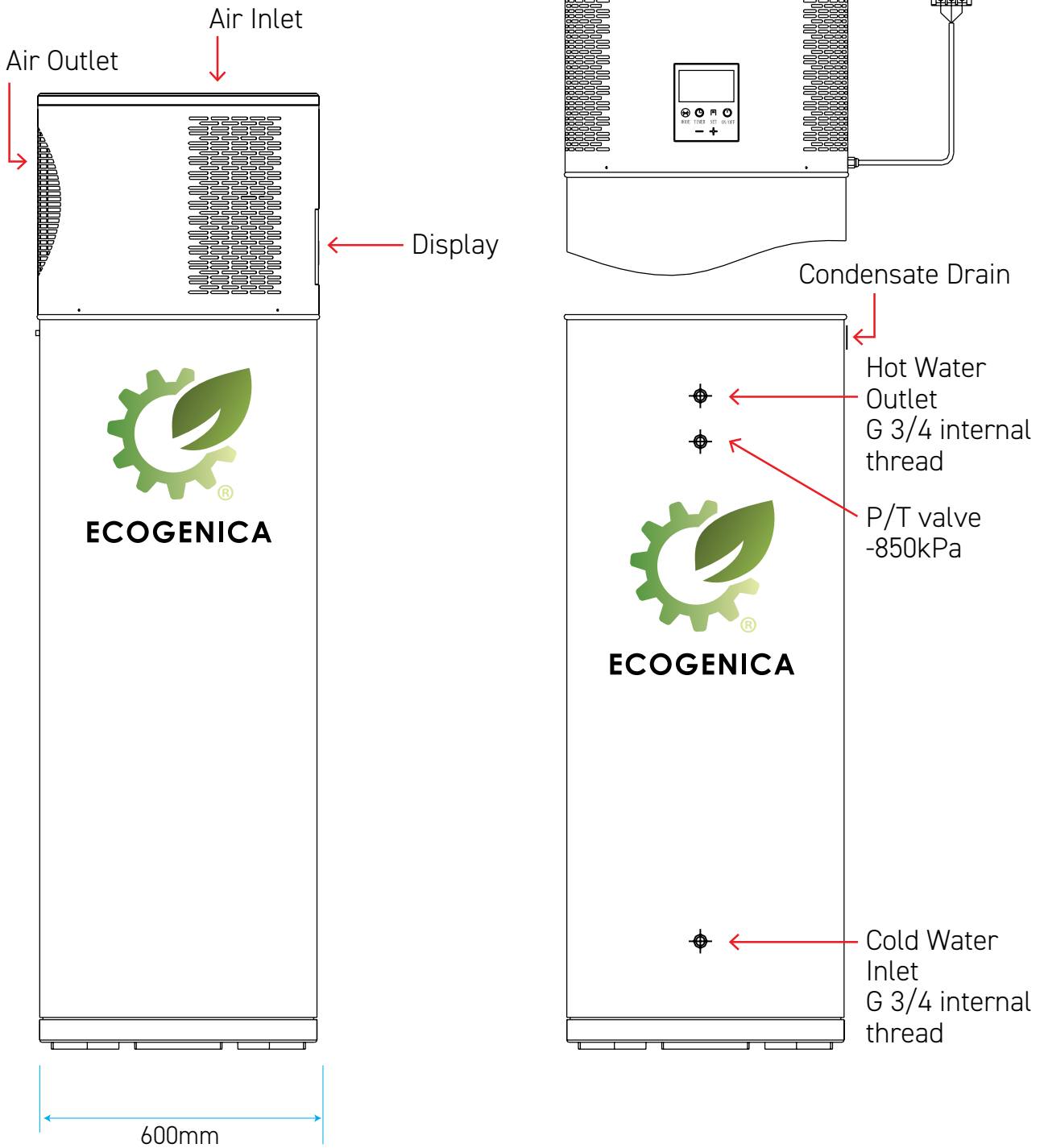

9 Electrical Circuit Diagram

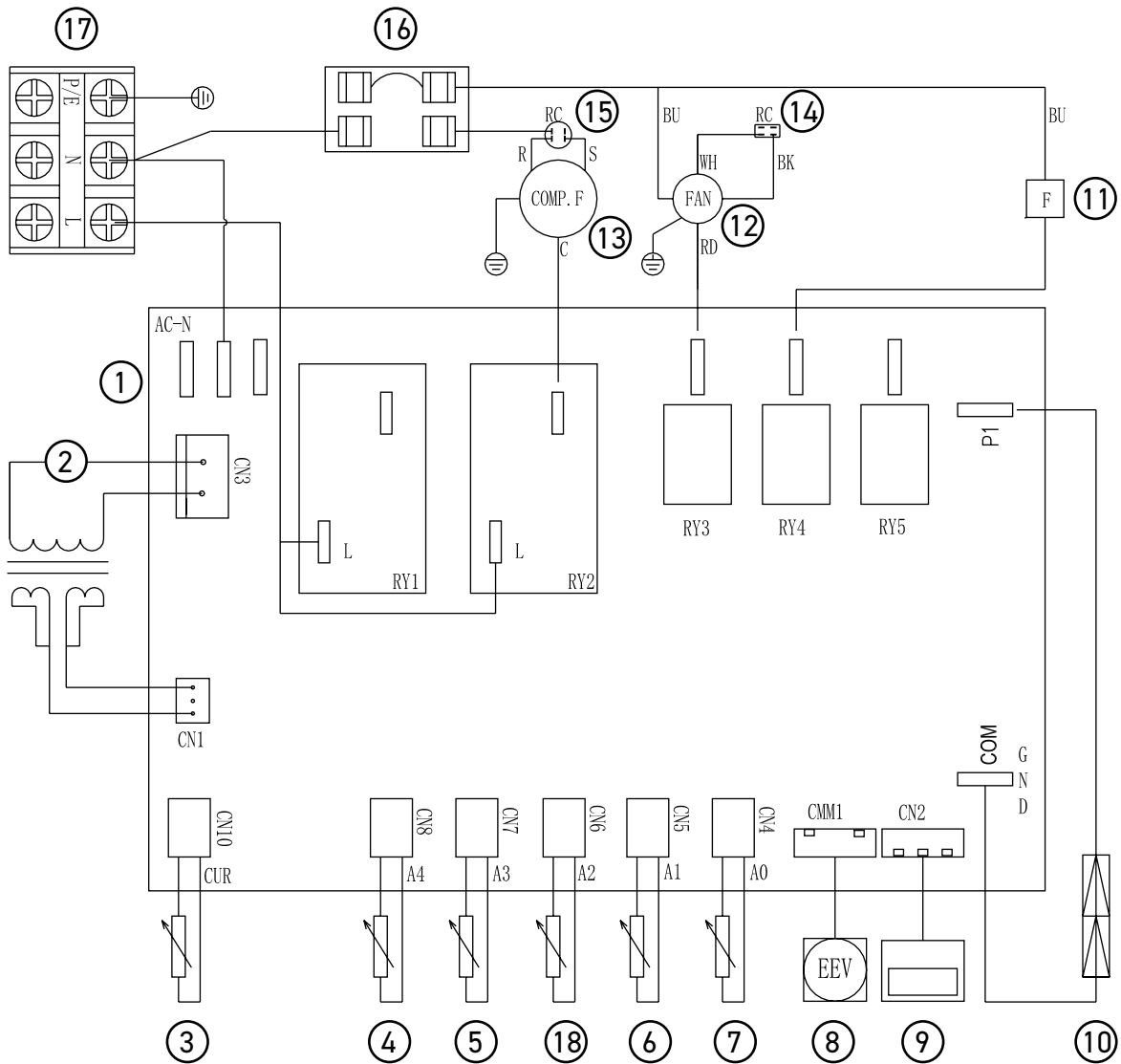

- 1 - Integrated Circuit Board
- 2 - Transformer
- 3 - Exhaust Temperature Sensor
- 4 - Gas Recovery Temperature Sensor
- 5 - Coiler Temperature Sensor
- 5 - Water Tank Temperature Sensor T1
- 7 - Ambient Temperature Sensor
- 8 - Electronic Expansion Valve
- 9 - Display

10 Installation

10.1 PIPING CONNECTIONS

Installation of the water inlet or outlet pipes:

The water inlet and outlet thread are 3/4 BSP (internal thread). Pipes must be heat resistant, durable and UV resistant (when doing outdoor installation).

Installation of the pipe for PTR valve: The valve thread specification is 1/2 BSP (internal thread)

Note: one way valve must be installed at the inlet.

All pipe work should be insulated with proper insulating material (weatherproof and UV resistant if exposed) to optimise energy efficiency.

To ensure the faultless operation, the unit must be installed vertically with a tilt no more than 1°, preferably in the direction of the condensate drain in order to favour the condensates drainage.

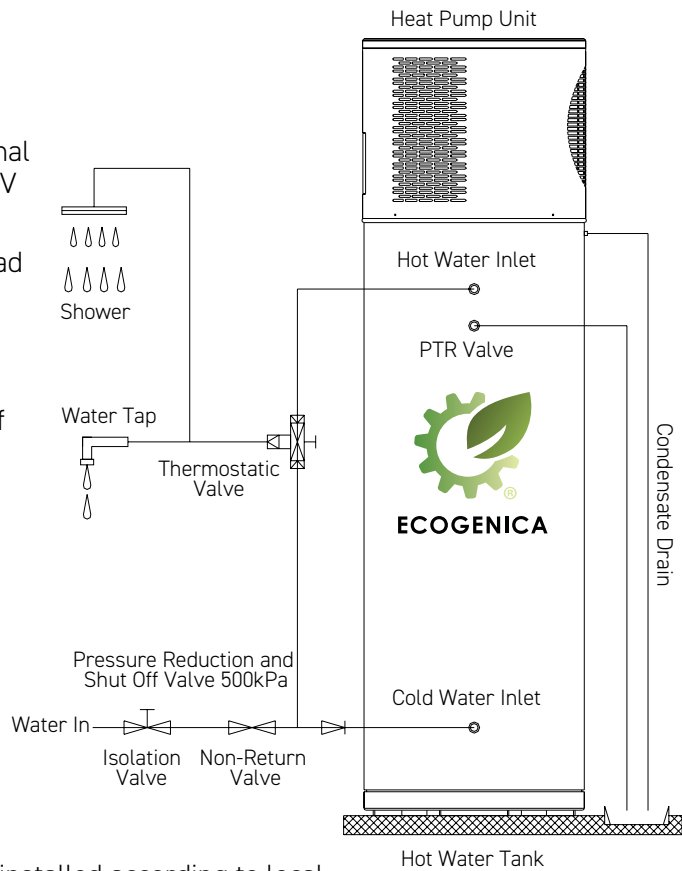

CAUTIONS

The temperature and pressure-relief valve must be installed according to local code. Not doing so will cause damage to the appliance and to other property.

The function of the temperature and pressure relief valve once installed on this water heater is to discharge high conditions. Therefore, it is strongly recommended that the pipe work connected to the relief valve is able to withstand water temperatures exceeding 99°C. Failure to follow this recommendation may result in a dangerous situation.

10.2 DIELECTRIC JOINT

Different metals between plumbing and tank materials and additionally the effect of hot water can cause the corrosion of one of the metals (generally the one in the tank is the metal attacked).

The dielectric joint will basically avoid any physical contact between the two metals, acting as an effective insulator and prevent this attack. How quickly this, or it at all, happens, depends a lot on the content of your water. It's pH, the dissolved minerals and the metals involved.

10.3 CONDENSATE DRAIN TUBES

This unit has an integrated condensation tray. The water collected in the tray drains out of the tube. It is important that a hose is attached to drain.

WARNING: - Never block or seal the outlet of the PTR valve or its drain for any reason. The warranty will be void if the relief valve or other safety devices are tampered with or if the installation is not in accordance with this manual.

10 Installation *(continued)*

10.4 THERMAL EXPANSION TANK

Thermal expansion is a natural process where heated water increases its volume. When this water is stored in a tank, this volume increase will in fact mean a pressure increase. This pressure increase can result in a dangerous situation. If the safety settings on the relief valve are reached, then the relief valve will operate during the heating cycle.

Please contact a licensed professional, water supplier or plumbing inspector for information about this subject.

10.5 PTR Valve

A temperature and pressure relief valve is supplied and must be installed in the tank port marked for this purpose. No valve or accessory of any type should be installed between the relief valve and the tank. Please observe local codes for the correct installation of relief valves.

The kW rating of the relief valve must be higher than 6kW to ensure that is always above the maximum output power of the water heater when operating with both electrical heater and heat pump and air at 40°C. The supplied PTR valve complies with this by having a power capacity of 10kW.

Connect the outlet of the relief valve to a suitable open drain so that the discharge water cannot contact any electrical parts, persons or animals and to eliminate any other possible risks.

Always use a valve of the same rated pressure and temperature as the PTR valve supplied with the unit.



WARNING

The pressure rating of the relief valve must not exceed 1000kPa, the maximum working pressure of the water heater as marked on the rating plate.

Relief valve easing gear should be operated. If water does not discharge freely when the lever is operated, the valve should be checked by an authorised agent.

The relief valve and relief valve drain pipe must not be sealed or blocked. Small amounts of water may leak from relief valve during heating cycles.

10 Installation *(continued)*

10.6 TEMPERATURE MIXING DEVICE

Eco Alliance Pty Ltd recommends the installation of a temperature limiting device between the water heater and the hot water outlets in a bathroom or similar usage point in order to reduce the risk of scalding.

10.7 PRESSURE LIMITING VALVE

This water heater is designed for direct connection to mains water supply. In case the mains supply pressure exceeds 800kPa, a pressure limiting valve must be installed.

A minimum water supply pressure of 200kPa is required to assure the effective operation of this water heater. In installations where the mains water supply pressure exceeds that specified for this product, an approved pressure limiting valve is required and must be fitted. If the water is supplied with low pressure water, below the minimum working pressure for this product, then a pressure pump should be installed in order to minimise the forming of air traps in the hydraulic circuit.

10.8 EXPANSION CONTROL VALVE

A saturation index greater than +0.4 or in corrosive water areas where there are sufficient quantities of silica dissolved in the water may require the installation of an expansion control valve (ECV) in the cold water line, being the last valve installed prior to the water heater.

10.9 ELECTRIC REQUIREMENTS

Check the markings on the rating plate of the water heater to be certain the available power supply corresponds to the water heater requirements.

This water heater must be directly connected to a 230V-240VAC 50Hz mains power supply. When connected off grid, please make sure the 230V-240VAC 50Hz true sine wave power supply is available.

Do not connect to inverters providing square sine waves.

The water heater must be installed on its own circuit with a breaker switch installed directly at the switchboard.

To ensure the faultless operation, the unit must be installed vertically with a tilt no more than 1°, preferably in the direction of the condensate drain in order to favour the condensates drainage.

The appliance must be powered for the first time during the purge procedure after the tank was filled with water.



Warning

Proper ground connection is essential. The presence of water in the piping and water heater does not provide sufficient conduction for a ground. Nonmetallic piping, dielectric unions, flexible connectors etc, can cause the water heater to be electrically isolated.



10 Installation *(continued)*

Plumbers – Best Practice is required please conduct the following check list before you finish and ensure that Valves easily accessible and all drainage doesn't damage buildings.

Check your drains and piping for the following:

- 1. Drains are directed away from building footings,
- 2. Fall continuously from the valve to the point of discharge,
- 3. Does not pose a risk of injury to people,
- 4. The drain line discharges water away from the operator during the operation of the valve. Refer to AS/NZS 3500.4:2021 Section 5.11,
- 5. Copper piping is used, and you cannot use plastic pipes for drain lines, (AS/NZS 3500.4:2021, 2.5.2 (g)),
- 6. The drain lines are insulated for at least the first 500mm, note that these drains are still considered an "outlet" according to the definitions in the standards.

11 System Operation

11.1 DISPLAY

1 - **Disinfection:** When the unit is in disinfection mode, the Disinfection icon will be displayed on screen.

2 - **Motor fan:** Feature not required.

3 - **E-heater:** Only available in FRE /C models.

4 - **Defrosting:** When the device enters the defrost state, the defrost icon will be displayed on the screen.

5 - **Heating water:** When the machine is turned on, the icon of heating water will be displayed on the screen.

6 - **Controller locked:** When the machine is turned on, the icon will be displayed on the screen for child protection. Press start button 4 times to disengage.

7 - **Sensor:** The icon will display on the screen water temperature at the mid point sensor.

8 - **Water temperature setting.** When the control panel will display the current required temperature at the mid-point sensor; when setting the required temperature, the water temperature will change accordingly.

9 - **Clock:** The clock will be displayed all the time. When in clock setting mode, the clock will show the setting time, outside of this mode the clock will display the current set time.

10 - **Time on:** If a TIME ON timer has been set, the TIME ON icon will be displayed on screen.

11 - **Alarm lamp:** If the device fails, the alarm indicator lamp will display with error code.

12 - **Time off:** If a TIME OFF timer has been set, the TIME OFF icon will be displayed on screen.

13 - **Set key:** See Page 34. And we recommend you contact your service agent for assistance.

14 - **Turning the unit ON:** Make sure the water tank is full of water before starting the machine. To turn on the unit, unlock the control panel and press and hold the on / off button for 3 seconds.

Turning the unit OFF: To turn off the unit, unlock the control panel and press and hold the on / off button for 3 seconds.

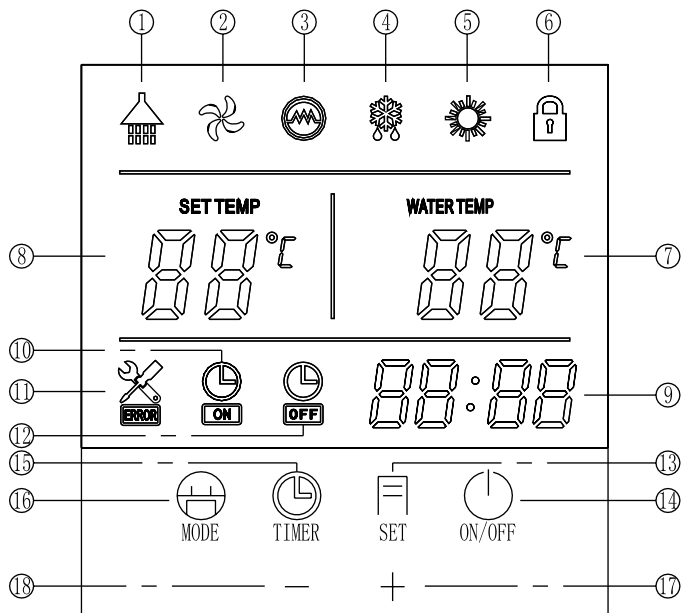

15 - **Setting the TIME ON Timer:** If the timer is set to time on, the unit will automatically run once between the clock setting and the last 24 hours.

16 - **Start the electric heating mode;** Not available in this model.

17 - **Increase:** To raise the temperature, unlock the control panel and continue pressing the "+" button. Set the clock. To increase the time, press the "+" button. When querying parameters, enter the query set function, and press the "+" key to view various operating parameters. When setting parameters, enter the setting function, and press the "+" key to view various setting parameters.

18 - **Decrease:** To reduce the temperature, unlock the control panel and continue to press the "-" button. Set the clock. To shorten the time, press the "-" button. When querying parameters, enter the query function, and press the "-" key to view various operating parameters. When setting parameters, enter the setting function, and press the "-" key to view various setting parameters.

11.2 BUTTON COMBINATION FUNCTIONS

13+15 Press simultaneously:

Forced defrost mode:

Press and hold the key combination for 5 seconds to enter the forced defrosting mode.

13+16 Press simultaneously:

Reset parameters: |

In the shutdown state, press the key combination for 3 seconds to reset the parameters. The reset is successful, and the buzzer rings for 2 times.

12 System Trouble Shooting

12.1 TROUBLE SHOOTING

DISPLAY	DESCRIPTION	SOLUTION
E1	Protection of high pressure switch	Switch off power and reconnect. If this fault occurs frequently, please contact the authorised contractor
E3	Electric overheating protection	Water tank is short of water or protection fails please contact the authorised contractor
E7	Compressor exhaust temperature high temperature protection	During heating operation, when the ambient temperature is higher than $>35^{\circ}\text{C}$. Compressor exhaust temperature is greater than 115°C hours The pump host will automatically shut down for protection. The operation panel displays E7. When the compressor exhaust temperature is lower than 95°C . The water tank is restored.
E8	Communication failure	The communication line is disconnected or the display screen is damaged.
P1	Water tank temperature sensing fault	Notify authorised contractor.
P3	Evaporator temperature sensor error	Notify authorised contractor.
P4	Compressor suction temperature sensor error	Notify authorised contractor.
P5	Ambient temperature sensor error	Notify authorised contractor.
P7	Compressor discharge temperature sensor error	Notify authorised contractor.

NOTE

The diagnostic codes listed above are the most common.

If a diagnostic code not listed above is displayed, please contact for technical assistance.

For all Models

13 System Maintenance

13.1 CLEANING

The heating effect depends on whether there is dust, mud or other on the surface of the evaporator. Sundries block the air inlet channel and lose the effect of heat exchange with the air, resulting in heating efficiency.

Customers are required to ensure that the heat pump remains clean and free from debris.



Before
Cleaning



After
Cleaning

13.2 CHECK THE ANODE

It's essential to replace the anode, when necessary, as the anode is installed in your water heater to protect the cylinder, but it will slowly wear out over time. It is recommended that you replace the anode during a five-year service, or before if you have poor water quality in your area, the maximum time between replacement is 8 years. Poor water quality occurs when water supplies that are either softened, desalinated, or where the water supply alternates between a water tank and a public supply or another source.

Typically, a magnesium anode is fitted as the standard option. During anode replacement the correct selection of the anode is crucial to maintain the warranty on the water heater cylinder.

- Turn off the heat pump unit (disconnect the power supply directly)
- Turn off the stop valve ① and turn on the stop valve ⑤ and faucet to drain the tank
- Locate the anode position and unscrew the anode cover
- Use an Allen wrench to loosen
- Check the consumption of the anode, if it is used up, it needs to be replaced immediately, so as not to affect the quality of the water
- To restore the state of use, be sure to fill up the water first and observe whether there is any leakage
- Turn on the power, turn on the heat pump to heat the water to the termination temperature, and then observe whether there is any leakage here, before leaving.

For all Models

13 System Maintenance *(continued)*

13.3 PTR MAINTENANCE

Periodic operation of the valve is recommended to ensure smooth water flow.

If the water does not flow freely, change valve.

In order to avoid the expansion and deformation of the water tank due to excessive pressure, the service life of the water tank will be affected.

- Find the position of the valve
- Carefully release the valve with the lever to release some water from the tank.
Note: Please use the water discharged from the container to avoid damage to other items
- If the water is flowing, the valve is still in proper working order
- If the water does not flow freely, the valve is out of function and needs to be replaced
- If the valve needs to be replaced, please contact your plumber or our service team for further assistance.



13.4 CHECK

Please check the machine regularly for any damage, if there is obvious damage, please contact our maintenance team. In some cold areas (below zero degrees Celsius), if the system stops working for a long time, all the water in the water tank should be released and re-installed in the water tank.

Reuse before filling with water to prevent the inner box from freezing.

Failure to do so may cause the machine to malfunction and, in severe cases, damage.

13.6 WATER QUALITY REQUIREMENTS FOR WATER SUPPLY (chloride and pH) **! IMPORTANT !**

In areas of water supplies with high chloride levels, water can corrode certain parts, causing them to fail. It is not suitable for heat pump units and storage tank units if the chloride content exceeds 200 mg/L. pH is a measure of whether water is alkaline or acidic.

Heat pump units and hot water tank units with a Ph value less than 6.0 are not guaranteed.

The water supply to rainwater storage tanks within urban agglomerations can be corrosive due to the dissolution of atmospheric pollutants.

Water with a pH value of less than 6.0 can be treated to increase the pH value, so it is recommended to analyze the quality of tap water before connecting to this type of water supply system.

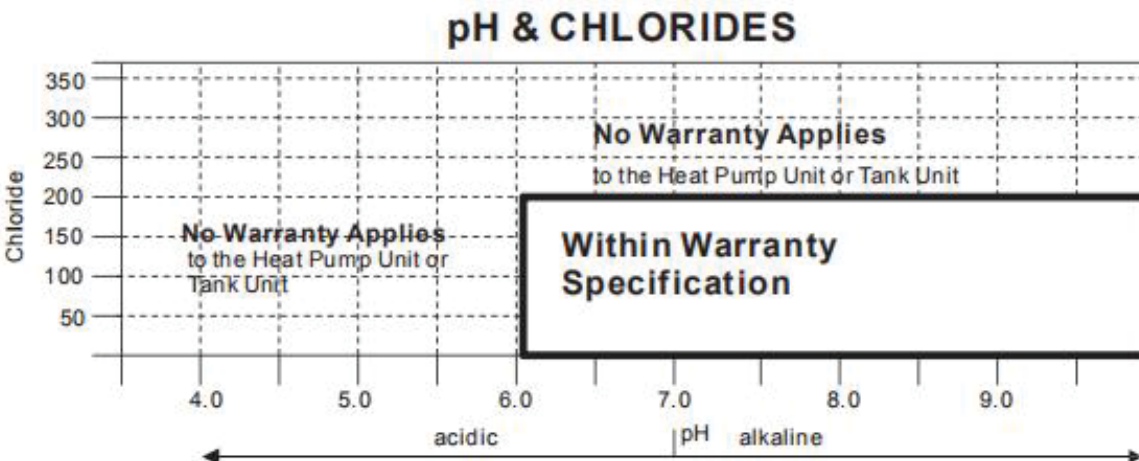

This page has been left intentionally blank

This page has been left intentionally blank

This page has been left intentionally blank

For all Models

14 Warranty

Disclaimer: Our Heat Pump units may require a technician to sign off on installations, as well as any other regulations across different jurisdictions. Please seek the correct guidance on how to proceed when installing the units ordered to best meet the regulations in all states.

NOTICE TO CONSUMER

Our goods come with guarantees that cannot be excluded under the Australian Consumer Law. You are entitled to a replacement or refund for a major failure and compensation for any other reasonably foreseeable loss or damage. You are also entitled to have the goods repaired or replaced if the goods fail to be of acceptable quality and the failure does not amount to a major failure.

Note: We recommend all consumers safely store receipts, invoices, warranties and any installation records to allow for faster processing of warranty claims.

14.1 TERMS OF WARRANTY

1. The warranty terms in this Ecogenica Customer Product Manual FRE relates only to the Ecogenica FRE/FREC Range of Heat Pump Water Heater System, namely:
 - a) Ecogenica® EG-215FRE & EG-215FREC, EG-290FRE & EG-290FREC and EG-330FRE & EG-330FREC models; and
 - b) EG-260FR & EG-260FRC models.

The warranty period are as follows from the date of installation:

- 7 Year warranty for the Tank, ● 5 Year warranty for the Compressor, ● 2 Year warranty for Servicing,
- 12 months for Parts only and any and all Labor costs associated with diagnosis, removal of the faulty part and installation of replacement parts will solely be the owner's responsibility and solely at the owner's cost.

The benefits conferred by this Warranty are in addition to all other rights and remedies in respect of the Heat Pump Water Heater System, which the purchaser has under the law including the Competition and Consumer Act 2010 and consumer protection legislation of the States and Territories. Nothing in this Warranty has the effect of excluding, restricting or modifying those rights.

2. Ecogenica will repair or provide parts for repair or replacement, where defects arise from faulty materials.
3. Ecogenica is responsible for reasonable costs associated with legitimate warranty claims, as determined by Ecogenica. To determine whether a warranty claim is legitimate, Ecogenica may send an Ecogenica accredited service agent to inspect the product. Ecogenica is not responsible for:
 - (a) any costs that are not pre-approved in writing by Ecogenica; and
 - (b) any costs associated with a product which is determined upon inspection not to be covered by this warranty.

Any reasonable costs incurred by the consumer that is associated with making a legitimate warranty claim will be reimbursed by Ecogenica.

Enquiries relating to warranty coverage and claims for Ecogenica products or services must be made by contacting Ecogenica.

An Ecogenica accredited service agent or the Ecogenica service department can repair or replace product components, subject to Ecogenica terms and conditions of warranty. Ecogenica can, in addition, provide information on operation and maintenance of Ecogenica products. Ecogenica contact details are on the back of this document.

14.2 WARRANTY CONDITIONS

1. The person making the claim must be the owner of the Product or have written authorisation to act on behalf of the owner which must be provided to Ecogenica.
2. The person making the claim must notify Ecogenica as soon as they notice any defects without delay, and the product must be within its warranty period as set out in the terms of warranty.
3. The warranty applies to products manufactured on or after the date of publication of this warranty.
4. The terms of warranty take effect from the date of completion of installation of the Product and full payment of the Product. Ecogenica reserves the right to request proof of purchase or a copy of the certificate of compliance (this is required by law to be issued by the installer) to verify the date of completion of installation prior to commencing any warranty work.

Where the date of completion of installation is not known, then this warranty will commence 2 months after the date of manufacture. The date of manufacture is stated on the data plate of the appliance.

5. Prior to any inspection, service, repair or replacement undertaken pursuant to the warranty on a Heat Pump Water Heater System, the following must occur:
 - a. The warranty works must be authorised by Ecogenica; and
 - b. Proof of purchase and the certificate of compliance must be submitted to Ecogenica.
6. The Heat Pump Water Heater System must be installed, commissioned, serviced, repaired and removed in accordance with the installation instructions supplied by Ecogenica for the Heat Pump Water Heater System, and in accordance with all relevant statutory and local requirements of the state/province/municipality in which the Heat Pump Water Heater System is installed.
7. All Heat Pump Water Heater Systems must be operated and maintained in accordance with the Ecogenica operating instructions.
8. The warranty only applies to the Heat Pump Water Heater System and original or genuine (company) component replacement parts provided by Ecogenica. The warranty does not cover any plumbing or electrical parts supplied by the installer and that is not an integral part of the Heat Pump Water Heater System. Such parts would include, but is not limited to, pressure regulating valve, limiting valves, check valves, tempering valves, electrical switches or fuses.

9. To the extent permitted by law, Ecogenica shall not be liable under this Warranty for any consequential loss or damage or any incidental expenses resulting from any breach of this warranty, including but not limited to, claims for damage to buildings, roofs, ceilings, walls, foundations, gardens, personal belonging or household effects, fixtures and fittings, or any other consequential loss, damage or inconvenience, either directly or indirectly due to the Heat Pump Water Heater System or component(s) related to the system or its operation including but not limited to leakage.
10. Where a failed component or Heat Pump Water Heater System is replaced under warranty, the balance of the original warranty period will remain effective. The replaced part or Heat Pump Water Heater System does not carry a new warranty.
11. Ecogenica reserve the right to have the installed product returned to the factory for inspection.
12. Products eligible for repair may be replaced by refurbished goods of same type rather than being repaired. Refurbished parts may be used to repair/replace the Products.
13. Where the Heat Pump Water Heater System is not installed in accordance with the installation instructions or installed in a position that does not allow safe, ready access as determined by the attending service person, the service may be refused at their discretion. Any cost to access the site safely, including the cost of additional materials, handling and/or safety equipment, will be charged to the consumer and will be the consumer's responsibility.
14. The Heat Pump Water Heater System must be sized to supply the hot water demand in accordance with the guidelines in the Heat Pump Water Heater System Literature.

14.3 WARRANTY EXCLUSIONS

Products supplied by Ecogenica are subject to warranties that cannot be excluded by law. Any breach of condition or warranty is limited to the repair or replacement of the Product, the supply of an equivalent Product, the payment of the cost of repairing or replacing the Product or acquiring an equivalent as determined by Ecogenica.

Repair and replacement work will be carried out as set out in the Heat Pump Water Heater System terms of warranty. However the following exclusions may void the warranty and may incur additional service charges and/or cost of parts:

15. Damage to the Heat Pump Water Heater System or any component, including accidental damage, natural disasters, acts of God, storm damage, vandalism.
16. Failure due to abuse, misuse or neglect, improper maintenance or failure to maintain and incorrect or unauthorised installations;
17. Failure or damage caused by alterations, service or repair work carried out by persons other than Ecogenica accredited service agents or the Ecogenica service department.
18. Where no fault is found with the Heat Pump Water Heater System or its components and the issue is related to the plumbing installation or is due to a direct or indirect failure of water, electric or gas supplies, corrosive atmosphere or other issues not caused by a fault of the Product including but not limited to:
 - a. excessive discharge from the temperature and/or the pressure relief valve due to high water pressure;
 - b. excessive water pressure;
 - c. no flow of hot water;
 - d. water leakage;
 - e. where the supply of electricity or water does not comply with relevant codes or acts or the power supply is cut;
 - f. the overflow vent drain has not been installed or it is blocked or corroded;
 - g. rust due to a corrosive atmosphere.
19. Where the unit fails to operate or fails because of excessive cold or ice formation in the piping to or from the Heat Pump Water Heater System.
20. Where any faults arise from connecting to a water source that is unfiltered such as dams, bores, rivers etc.
21. The Heat Pump Water Heater System being relocated from its original point of installation.
22. Operating the water heater and components when not completely filled with water.
23. This warranty applies to Heat Pump Water Heater Systems connected to the energy source listed on the data label of the Product.
24. This warranty does not apply to damage caused by sludge and/or sediment in the water supply.
25. Repair and/or replacement of the Heat Pump Water Heater System due to scale formation above 200ppm (water hardness) in the waterways or the effects of either corrosive water or water with a high chloride or low PH level when the water heater.
26. Where the Ecogenica Heat Pump Water Heater System is in a position that does not comply with the Heat Pump Water Heater System installation instructions or relevant statutory requirements, causing the need to dismantle or remove cupboards, doors or walls, or require the use of special equipment to bring the Heat Pump Water Heater System to floor or ground level or to a serviceable position.
27. Labour costs incurred due to an Ecogenica accredited service agent performing checks which should have been carried out by the consumer in accordance with the operating instructions and where no defect is found.

Water heating is the largest single source of green house emissions accounting for almost a quarter of household energy use.



Your new Ecogenica® Quick Series Heat Pump uses a small amount of energy to move heat from one location to another. Heat is absorbed by ozone-friendly R290, a natural refrigerant **which does not contribute to global warming.**

We support the Australian Government in its commitment to transforming our energy supply system into one that is cheap, clean and reliable.

This lays the foundation for future generations to enjoy more secure, reliable and affordable energy.

You can choose an Ecogenica® product safe in the knowledge that our innovative technology is focused on energy AND environment savings. Our hot water pumps are CFC free and utilise renewable energy, extracted from the air.

**ECOGENICA® – A smart choice for the environment
+ a smart choice for you**

Contact us:

CALL: **1300 341 010**

VISIT: ecogenica.com.au

6 Braeside Drive, Braeside, Vic, 3195 Australia



ECOGENICA
INNOVATION MEETS TECHNOLOGY